

Draft
**VISTA CANYON
SPECIFIC PLAN**



Prepared for:

City of Santa Clarita
Department of Community Development
23920 Valencia Boulevard
Santa Clarita, California 91355
Contact: Jeff Hogan, Senior Planner

Prepared by:

Vista Canyon Ranch, LLC
27451 Tourney Road, Suite 100
Valencia, California 91355
Contact: Glenn Adamick

April 2010

FINAL

VISTA CANYON SPECIFIC PLAN

(Specific Plan No. 07-001)

Prepared for:

City of Santa Clarita
Department of Community Development
23920 Valencia Boulevard
Santa Clarita, California 91355
Contact: Jeff Hogan, Senior Planner

Prepared by:

Vista Canyon Ranch, LLC
27451 Tourney Road, Suite 100
Valencia, California 91355
Contact: Glenn Adamick

April 2011

TABLE OF CONTENTS

Section	Page
1.0 INTRODUCTION	1
1.1 INTENT AND PURPOSE OF SPECIFIC PLAN	1
1.2 ORGANIZATION OF THE SPECIFIC PLAN	4
1.3 PROJECT LOCATION	5
1.3.1 LOCATION	5
1.3.2 SURROUNDING USES	5
1.3.3 SITE CHARACTERISTICS	6
1.4 AUTHORITY	12
1.5 THE SPECIFIC PLAN'S RELATIONSHIP TO THE GENERAL PLAN, SANTA CLARITA MUNICIPAL CODE, AND OTHER LAWS	12
1.5.1 RELATIONSHIP TO THE GENERAL PLAN	12
1.5.2 RELATIONSHIP TO THE SANTA CLARITA MUNICIPAL CODE	12
1.6 COMPLIANCE WITH CALIFORNIA ENVIRONMENTAL QUALITY ACT	14
1.7 COMPLIANCE WITH OTHER LAWS AND REGULATIONS	14
1.7.1 GLOBAL WARMING SOLUTIONS ACT OF 2006 (AB 32)	14
1.7.2 TRANSPORTATION PLANNING AND PROGRAMMING (SB 375)	14
1.7.3 ENERGY EFFICIENCY STANDARDS (TITLE 24)	15
2.0 DEVELOPMENT PLAN	17
2.1 INTRODUCTION	17
2.2 SPECIFIC PLAN OBJECTIVES	17
2.2.1 LAND USE PLANNING OBJECTIVES	18
2.2.2 ECONOMIC OBJECTIVES	19
2.2.3 RESOURCE CONSERVATION OBJECTIVES	19
2.3 LAND USE PLAN	19
2.3.1 LAND USE DESIGNATION ZONES*	23
2.3.2 PLANNING AREAS	23
2.3.3 OFF-SITE IMPROVEMENTS	25
2.4 MOBILITY PLAN	26
2.4.1 INTRODUCTION	26
2.4.2 EXISTING REGIONAL CIRCULATION AND ACCESS	29
2.4.3 LOCAL ROADWAY CIRCULATION AND ACCESS	29
2.4.4 PARKING PLAN	49
2.4.5 TRANSIT PLAN	50
2.4.6 TRAILS PLAN	51
2.5 SANTA CLARA RIVER CORRIDOR	52
2.5.1 RESOURCE DESCRIPTION	52
2.5.2 MITIGATION REQUIREMENTS	56
2.6. SUSTAINABILITY PLAN	65
2.6.1 INTRODUCTION	65
2.6.2 APPLICATION OF PROJECT DESIGN FEATURES TO VISTA CANYON	65
2.7 LANDSCAPE PLAN	68
2.8 PARKS AND RECREATION PLAN	68
2.9 PHASING PLAN	69

3.0	INFRASTRUCTURE DEVELOPMENT PLAN	75
3.1	INTRODUCTION	75
3.2	GRADING PLAN.....	75
	3.2.1 EXISTING CONDITIONS.....	75
	3.2.2 PROPOSED CONDITIONS.....	76
3.3	DRAINAGE/WATER QUALITY	76
	3.3.1 EXISTING CONDITIONS.....	76
	3.3.2 PROPOSED CONDITIONS.....	78
3.4	BANK PROTECTION/STABILIZATION	84
	3.4.1 EXISTING CONDITIONS.....	84
	3.4.2 PROPOSED CONDITIONS.....	87
3.5	WATER SERVICE/RECYCLED WATER	92
	3.5.1 EXISTING CONDITIONS.....	92
	3.5.2 PROPOSED CONDITIONS.....	92
3.6	WASTEWATER SERVICE	93
	3.6.1 EXISTING CONDITIONS.....	93
	3.6.2 PROPOSED CONDITIONS.....	93
3.7	DRY UTILITIES	93
	3.7.1 EXISTING CONDITIONS.....	93
	3.7.2 PROPOSED CONDITIONS.....	95
3.8	ROADWAY DESIGN.....	96
	3.8.1 EXISTING CONDITIONS.....	96
	3.8.2 PROPOSED CONDITIONS.....	98
3.9	TRANSPORTATION DEMAND MANAGEMENT.....	100
	3.9.1 EXISTING CONDITIONS.....	100
	3.9.2 PROPOSED CONDITIONS.....	100
4.0	DEVELOPMENT REGULATIONS.....	102
4.1	PURPOSE	102
4.2	CONSISTENCY WITH ADOPTED PLANS	102
4.3	RELATIONSHIP TO CITY'S UNIFIED DEVELOPMENT CODE	102
4.4	EXISTING USES AND SEVERABILITY.....	102
4.5	ADMINISTRATION	103
4.6	LAND USE DESIGNATIONS	103
	4.6.1 LAND USE PLAN AND ZONES	103
4.7	SITE DEVELOPMENT STANDARDS.....	104
4.8	ALLOWED LAND USES/PERMIT REQUIREMENTS	105
	4.8.1 INTRODUCTION	105
	4.8.2 PERMIT REQUIREMENTS	106
4.9	TRANSFER/CONVERSION/ADJUSTMENT REGULATIONS	111
	4.9.1 PURPOSE AND INTENT	111
	4.9.2 PA-2 AND PA-3 TRANSFERS.....	111
	4.9.3 PLANNING AREA BOUNDARY, ACREAGE AND ADJUSTMENTS	112
4.10	SIGNAGE REGULATIONS	113
	4.10.1 PURPOSE AND INTENT	113
	4.10.2 APPLICABILITY AND CONFORMANCE	113
4.11	PARKING REGULATIONS.....	114
	4.11.1 PURPOSE AND INTENT	114

4.11.2	PARKING REGULATIONS	114
4.11.3	PARKING REQUIREMENTS.....	115
5.0	DESIGN GUIDELINES.....	117
5.1	PURPOSE AND INTENT.....	117
5.2	GENERAL GUIDELINES.....	117
5.2.1	DESIGN THEMES	117
5.2.2	SITE PLANNING.....	118
5.2.3	ARCHITECTURE.....	118
5.2.4	FENCING.....	120
5.3	OTHER APPLICABLE ARCHITECTURAL GUIDELINES.....	120
5.4	APPLICATION PROCESS	121
6.0	SPECIFIC PLAN IMPLEMENTATION	122
6.1	PURPOSE AND INTENT.....	122
6.2	IMPLEMENTATION PROCEDURES AND PHASING	122
6.3	IMPLEMENTATION OF TRANSFER/CONVERSION/ADJUSTMENT REGULATIONS	123
6.4	SPECIFIC PLAN - SUBSTANTIAL CONSISTENCY	124
6.5	AMENDMENT PROCEDURES	124

LIST OF FIGURES

Figure	Page
1.0-1 Regional Location.....	7
1.0-2 Vicinity Map.....	8
1.0-3 Plan Area Aerial	9
1.0-4 Development Surrounding Specific Plan.....	10
1.0-5 Site Photographs.....	13
2.0-1 Land Use Plan	21
2.0-2 Specific Plan Circulation Network.....	28
2.0-3 Mobility Plan.....	33
2.0-4 Road Section (Lost Canyon Road South of Jakes Way).....	34
2.0-5 Road Section (Roundabout "A": Lost Canyon Road at Jakes Way)	35
2.0-6 Road Sections (Lost Canyon Road (Jakes Way to Vista Canyon Road).....	36
2.0-7 Road Sections (Lost Canyon Road to La Veda Avenue)	37
2.0-8 Road Sections (Lost Canyon Road East of La Veda Avenue).....	38
2.0-9 Road Sections (Vista Canyon Road/Vista Canyon Road Bridge (North))	39
2.0-10 Road Sections (Vista Canyon Road SR-14 Underpass Improvements).....	40
2.0-11 Road Sections (Vista Canyon Road (South)).....	43
2.0-12 Road Sections (Roundabout at Vista Canyon Road and "A" Drive).....	44
2.0-13 Road Sections (Vista Square Drive ("Main Street"))Figure 2.0-14 Road Sections (A, B, and Q Drives).....	45
2.0-15 Road Sections (C, D and G Drives)	47
2.0-16 Road Sections (E, F, H, I, J, K, L, M, N, O, and P Drives).....	48
2.0-17 Transit Center Conceptual Site Design.....	53
2.0-18 Typical Trail Sections (cross-sections of various trail types)	54
2.0-19 Existing Santa Clara River Within Project and Vicinity	55
2.0-20 Location of Mitigation Areas	58
2.0-21 Typical Channel Cross-Section.....	63
2.0-22 Conceptual Landscape Plan.....	70
2.0-23 Parks and Recreation Plan.....	71
2.0-24 Conceptual Park Concept Designs (Oak Park).....	72
2.0-25 Conceptual Park Concept Designs (PA-2 Park)	73
2.0-26 Conceptual Park Concept Designs (Community Garden).....	74
3.0-1 Conceptual Grading Plan	77
3.0-2 Drainage and Water Quality Plan.....	80
3.0-3 Conceptual Illustration of Treatment Control BMPs.....	85
3.0-4 Conceptual Illustration of Treatment Control BMPs.....	86
3.0-5 Cross-Section of Conceptual Design of Buried Bank Stabilization Relative to Typical Trail Section.....	89
3.0-6 Soil Excavation and Backfill Process.....	90
3.0-7 Photographs of Buried Bank Stabilization.....	91
3.0-8 On-Site Potable and Non-Potable Water Systems	94

LIST OF TABLES

Table	Page
2.0-1 Specific Plan Summary	20
2.0-2 Land Use Plan Statistical Summary	
2.0-3 Comparison of Parking Levels	50
2.0-4 Riparian Scrub Plant Palette	60
2.0-5 Alluvial Scrub Plant Palette	61
2.0-6 Great Basin Sage Scrub Plant Palette	62
4.0-1a Site Development Standards Matrix(PA-1 and PA-2).....	104
4.0-1b Site Development Standards (PA-3)	105
4.0-2 Allowed Land Uses and Permit Requirements	107

LIST OF APPENDICES

1.0-1	Legal Description
1.0-2	Consistency Analyses
	General Plan Consistency Analysis
	OVOV Consistency Analysis
1.0-3	Tentative Tract Map No. 69164 (revised map)
2.0-1	Parking Demand Analysis, Vista Canyon Transit-Oriented Development (Planning Areas 1 and 2)
2.0-2	Vista Canyon Sustainability Plan
5.0-1	Vista Canyon Specific Plan Renderings

1.1 INTENT AND PURPOSE OF SPECIFIC PLAN

The Vista Canyon Specific Plan (Specific Plan) contains the development plans, infrastructure development plans, development regulations, design guidelines, and implementation program necessary to achieve the orderly and compatible development of Vista Canyon, a proposed new annexation area for the City of Santa Clarita (City). The Specific Plan facilitates quality residential, mixed-use, and non-residential transit-oriented development within the City, consistent with the goals and policies of the City's General Plan and draft General Plan Update (One Valley One Vision), by retaining or enhancing important River Corridor resources and other environmental amenities and concurrently establishing a community that is superior to the development otherwise allowable under conventional zoning regulations. The Specific Plan site, uniquely situated in proximity to the Metrolink rail line, also affords the opportunity to plan a new City/Metrolink transit center and accessory improvements to facilitate transit, reduce automobile trips, and create a place to live, work, play, and shop.¹ The applicant for this Specific Plan is Vista Canyon Ranch, LLC.

The Specific Plan has been prepared in conjunction with a pre-zone/zone change request to designate the area as Specific Plan (SP). The City of Santa Clarita Municipal and Unified Development Code (SCMC), section 17.16.030, establishes provisions for the SP Zone. The SP Zone is intended to achieve the following purposes:

- (a) Promote and protect the public health, safety, and welfare;
- (b) Implement objectives and policies of the General Plan;
- (c) Safeguard and enhance environmental amenities and enhance the quality of development;
- (d) Attain the physical, social, and economic advantages resulting from the comprehensive and orderly planned use of land resources;
- (e) Lessen congestion and assure convenience of access; secure safety from fire, flood, and other dangers; provide for adequate light, air, sunlight, and open space; promote and encourage conservation of scarce resources; facilitate the creation of a convenient, attractive, and harmonious community; attain a desirable balance of residential and employment opportunities; and expedite the provision of adequate and essential public services;

¹ The new transit center would replace the existing, temporary Via Princessa Metrolink Station, which was constructed after the 1994 Northridge Earthquake.

- (f) Facilitate development within the City in accordance with the General Plan by permitting greater flexibility and, consequently, more creative and imaginative designs for large-scale development projects than generally is possible under conventional zoning regulations;
- (g) Promote the more economical and efficient use of land while providing a harmonious variety of housing choices and retail/commercial activities, a high level of urban amenities, and preservation of natural and scenic qualities of open space; and
- (h) Provide a process for the initiation, review, and regulation of a large-scale, well-planned community that affords maximum flexibility within the context of an overall development program and specific, phased development plans coordinated with the provision of necessary public services and facilities.

This Specific Plan will achieve the purposes of the City's SP Zone, and will serve as the zoning code for the Specific Plan area (described more fully in **Section 2.0**).

In June 2007, the applicant filed a development application (Master Case No. 07-127) with the City. This application has since been revised by the Planning Commission and City Council at their hearings on the project. As revised, the following discretionary land use entitlement approvals will facilitate implementation of the Specific Plan:

- (a) **Pre-Zone/Zone Change No. 07-127a.** The property currently is zoned by the County of Los Angeles as M-1.5 (Light Industrial), A-1-1 (Light Agriculture - 1 acre minimum lot size), R-A-8,000 (Residential Agriculture -- 8,000-square-foot minimum lot size), and A-1-10,000 (Light Agriculture -- 10,000-square-foot minimum lot size). The applicant is proposing to amend the City Zoning Map by pre-zoning the property to (SP). The City Council must approve the pre-zone/zone change prior to the Los Angeles County Local Agency Formation Commission's (LAFCO) consideration of the applicant's proposed annexation request. The SP zoning would take effect upon approval of the annexation by LAFCO.
- (b) **Annexation No. 07-002a.** The property currently is located in unincorporated Los Angeles County, directly adjacent to the City of Santa Clarita. The applicant is requesting annexation of the site into the City, which is not currently within the City's Sphere of Influence, as defined by LAFCO. (LAFCO will act as a responsible agency in considering the City's Sphere of Influence amendment, and the applicant's annexation request.)
- (c) **General Plan Amendment No. 07-001a.** The City's General Plan currently designates the property for "Business Park" uses, with a Significant Ecological Area (SEA) overlay over portions of the property. The City's General Plan Land Use Concept (Exhibit L-3 of the General Plan) also presently identifies the property as a "Major Regional Subcenter." The

applicant proposes to amend the City's Land Use and Circulation Elements of the General Plan.

Specifically, the applicant requests that the City approve a General Plan Land Use Element Amendment to revise the land use designation for the property from BP (Business Park) to SP (Specific Plan) and to revise the SEA overlay boundary to correspond to the area designated SP-OS (Santa Clara River Corridor). The applicant also requests a General Plan Circulation Element Amendment to: (i) establish the alignment for Lost Canyon Road/Vista Canyon Road; (ii) reduce Lost Canyon Road from a six-lane roadway (Major Highway) to a four-lane roadway (Secondary Highway) from its westerly terminus in Fair Oaks Ranch to the future intersection of Lost Canyon Road and Vista Canyon Road; (iii) designate the proposed Vista Canyon Road Bridge across the Santa Clara River as a limited secondary highway permitting a total of two travel lanes and one auxiliary lane with a sidewalk and a bike path on one side; and (iv) remove Lost Canyon Road from the City's General Plan Circulation Element as a Major Highway from Vista Canyon Road to Sand Canyon Road.

- (d) **Specific Plan No. 07-001.** The applicant is proposing the adoption of this Specific Plan, which would establish the zoning, development plans, regulations, guidelines, and implementation provisions governing development within the Specific Plan area. The Specific Plan serves as a guide to implementation of the City's General Plan goals, policies, and objectives. Key components of the proposed Specific Plan include the land use plan, permitted use chart, development standards, circulation plan, conceptual landscape plan, pedestrian plan, trails plan, and sustainability plan.
- (e) **Tentative Tract Map No. 69164.** The applicant is proposing to organize the property into three Planning Areas (PA) and subdivide the property to facilitate construction of up to 1,100 residential units (including single-family lots and condominiums (up to 700 of which may be rented or leased)); up to 950,000 square feet of commercial and office, retail, theater, restaurant, and hotel uses; and parks, landscape/open space, River Corridor, bank protection, parking structures, and private drives. The applicant's tract map application also includes a request for approval of a proposed large lot parcel map for conveyance purposes.
- (f) **Conditional Use Permit No. 07-009.** The applicant is requesting approval of a Conditional Use Permit (CUP) to allow for the import of up to 500,000 cubic yards of dirt to accommodate development within the Specific Plan site. Import materials are to be from one or both of the following borrow sites: (i) the George Carvalho Santa Clarita Sports Complex Expansion; and/or (ii) the Centre Pointe Business Park. Development on both of the borrow sites previously has been approved by the City.

- (g) **Oak Tree Permit No. 07-002.** Buildout under the Specific Plan would impact oak trees on and off of the property. On-site, the applicant is requesting an oak tree permit to allow for removal of nine (9) of the 41 oak trees located on the project site, three of which are heritage size. One of the non-heritage trees proposed for removal would be relocated within the project site. The request also would permit the encroachment into the protected zone of nine (9) oak trees. Pruning or trimming of seven of these nine oak trees would be permitted under the oak tree permit. A total of 32 oak trees located on the project site, including 18 heritage-sized oak trees, would *not* be removed by the project.

For purposes of the “roundabout” at the Sand Canyon Road/Lost Canyon Road intersection, the requested permit would allow for encroachment into the protected zone of two oak trees. Encroachment for one tree is needed for the construction of a trail along Lost Canyon Road, east of the project site, and encroachment for the Sand Canyon Road tree is required by improvements to the intersection of Lost Canyon Road and Sand Canyon Road. Trimming or pruning also would be permitted on the tree along Lost Canyon Road to provide for trail clearance requirements.

In summary, the applicant is requesting an oak tree permit for the removal of up to nine (9) oak trees (three of which are heritage), encroachment into the protected zone of up to 11 oak trees, and trimming or pruning of up to 8 oak trees.

1.2 ORGANIZATION OF THE SPECIFIC PLAN

The Specific Plan is divided into six sections. The content of each section is described below.

Section 1.0, Introduction, describes the intent, purpose, structure, and organization of the Specific Plan. The section also describes the Specific Plan location, surrounding land uses, and site characteristics, including existing and planned land use designations. In addition, the section identifies special characteristics and existing conditions that make this Specific Plan area unique, and discusses the Specific Plan authorization. The section also addresses the relationship between the Specific Plan and the Santa Clarita General Plan, SCMC, and other laws and regulations.

Section 2.0, Development Plan, identifies the Specific Plan objectives and development plans, including the land use plan, land use plan statistics, mobility plan, Santa Clara River Corridor plan, sustainability plan, landscape plan, parks and recreation plan, and phasing plan. Each plan is described in detail in this section.

Section 3.0, Infrastructure Development Plan, describes the infrastructure and utilities needed to serve the Specific Plan area. Specifically, the section describes the backbone infrastructure systems (sewer, water, recycled water, water quality, and storm drainage), and utilities (gas, electricity, *etc.*), needed to support the Specific Plan. In addition, this section addresses the roadway design and transportation demand management program under the Specific Plan.

Sections 4.0, Development Regulations, sets forth the land use designations, site development standards, allowed land uses and permit requirements, permitted accessory uses, parking, and signage restrictions, and other regulations.

Section 5.0, Design Guidelines, address design themes, site planning, and architectural themes for each of the major land use designations within the Specific Plan.

Section 6.0, Specific Plan Implementation, describes the Specific Plan implementation procedures.

The Specific Plan, Volume II, includes appendices supporting the Specific Plan, including a legal description of the property (**Appendix 1.0-1**); General Plan Consistency Analysis (**Appendix 1.0-2**); Tentative Tract Map No. 69164 (**Appendix 1.0-3**); Parking Demand Analysis, Vista Canyon Transit-Oriented Development (Planning Areas 1 and 2) (**Appendix 2.0-1**); Vista Canyon Sustainability Plan (**Appendix 2.0-2**); and Renderings of the development contemplated by the Specific Plan (**Appendix 5.0-1**).

1.3 PROJECT LOCATION

1.3.1 LOCATION

The Specific Plan site consists of approximately 185 acres located in the northeastern portion of the Santa Clarita Valley within unincorporated Los Angeles County, directly adjacent to the City of Santa Clarita. The Specific Plan site includes a portion of the Santa Clara River Corridor. The City, located in the center of the Santa Clarita Valley, is approximately 35 miles northwest of downtown Los Angeles. The City generally is bound by Interstate 5 (I-5) and State Route 14 (SR-14) to the east, west, and south, and is about 1 mile from the Angeles National Forest boundary to the north and east. The Santa Clarita Valley planning area encompasses several distinct communities both within the City limits and in the surrounding unincorporated areas. The existing communities within the City include most of Newhall, Valencia, Saugus, and Canyon Country, with sub-communities of Sand Canyon and Placerita Canyon. The communities within the unincorporated areas are Stevenson Ranch, Castaic Junction, Val Verde, Hasley Canyon, and Castaic. The Specific Plan site is located within the Canyon Country community of the Santa Clarita Valley planning area.

Figure 1.0-1, Regional Location, depicts the Specific Plan area in relation to the region. **Figure 1.0-2, Vicinity Map**, illustrates the Specific Plan vicinity. **Figure 1.0-3, Plan Area Aerial**, illustrates the physical characteristics of the Specific Plan area and vicinity.

1.3.2 SURROUNDING USES

The Specific Plan site is surrounded by developed land uses, which are primarily residential. To the north of the Specific Plan site are SR-14 and residential and commercial development. The

Colony Townhomes, a multi-family residential community, is directly west of the Specific Plan site. The Fair Oaks Ranch community and an approximately 23-acre parcel located to the south and west of the site consist of single-family and multi-family residential units, an elementary school, community park, and vacant land. The existing Metrolink rail line and a commercial horse breeding facility with accessory residential and barn structures are located to the south of the Specific Plan site. The La Veda and Lost Canyon residential areas to the east consist of homes, a public elementary school, and a private school. **Figure 1.0-4, Development Surrounding Specific Plan**, depicts the surrounding development in relation to the Specific Plan site.

1.3.3 SITE CHARACTERISTICS

The Specific Plan area includes the site formerly occupied by the historic Mitchell Family home built in 1865 and the Mitchell Family cemetery. In 1860, Thomas Finley Mitchell became the first American resident of Soledad Canyon, settling to the west and south of Soledad Canyon and the Sand Canyon Road junction. Mitchell initially purchased 160 acres, and later acquired additional land that raised his land holdings to nearly 1,000 acres. The Sulphur Springs School District was started in 1879 with the use of a room in the Mitchell old adobe residence. This was the first schoolhouse in the now incorporated City of Santa Clarita. Sulphur Springs School District is the second oldest school district in Los Angeles County. Mitchell later donated the site of the present Sulphur Springs Elementary School, located east of the Specific Plan site. The Mitchell Family cemetery is located on an elevated portion of the Specific Plan site adjacent to SR-14, and is to be preserved and enhanced by the Specific Plan.

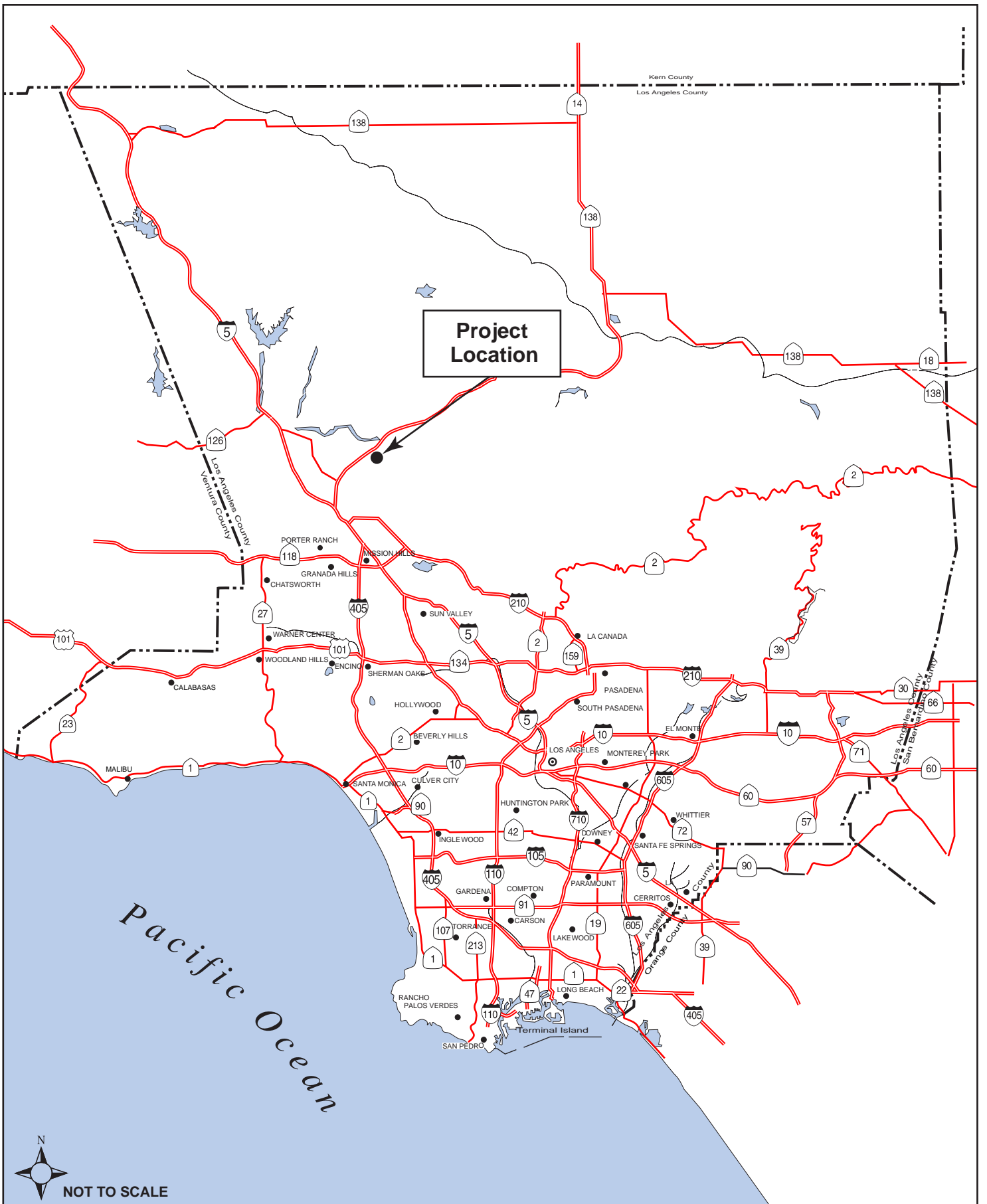

Figure 1.0-1

Regional Location

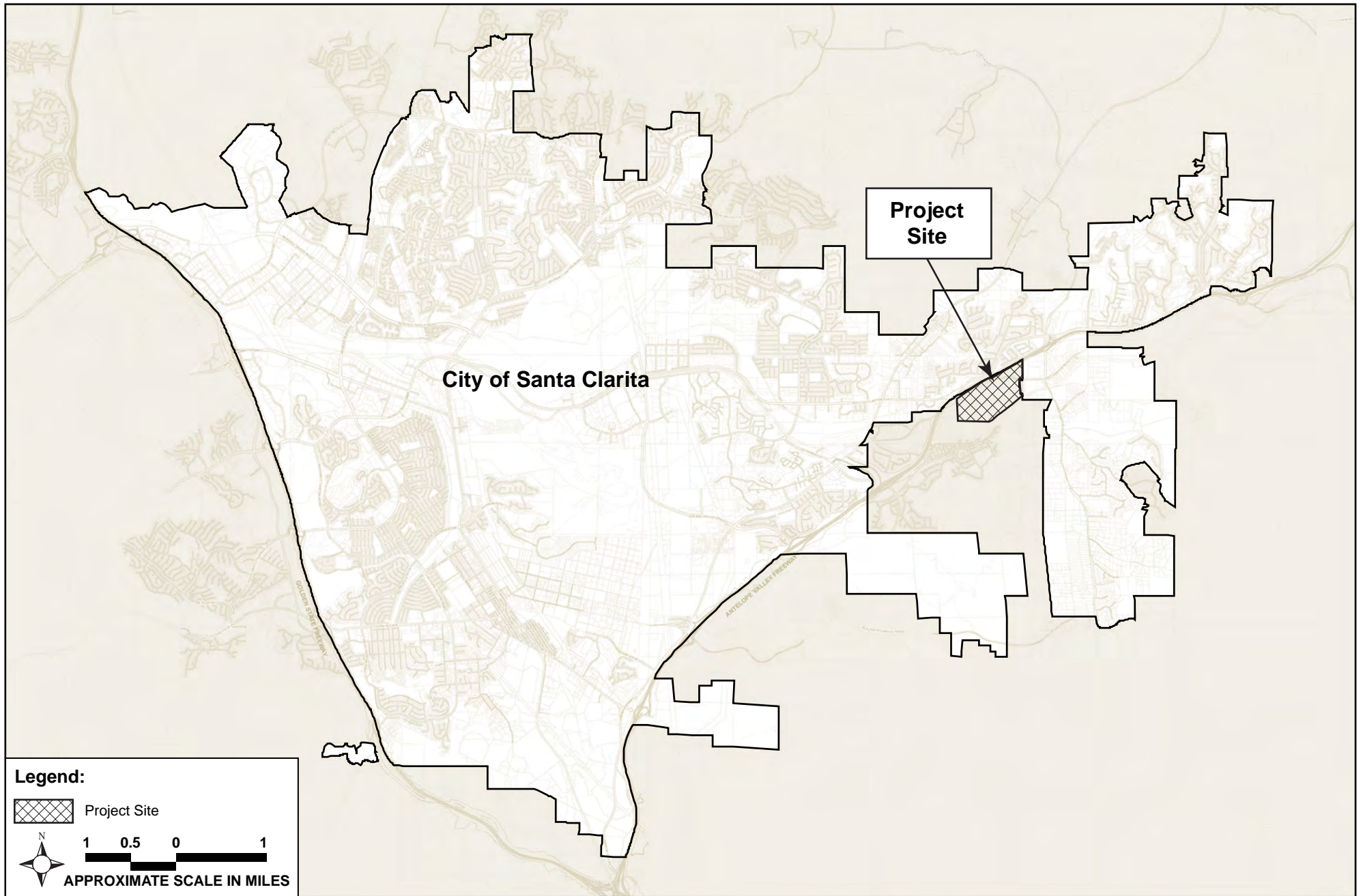

Figure 1.0-2

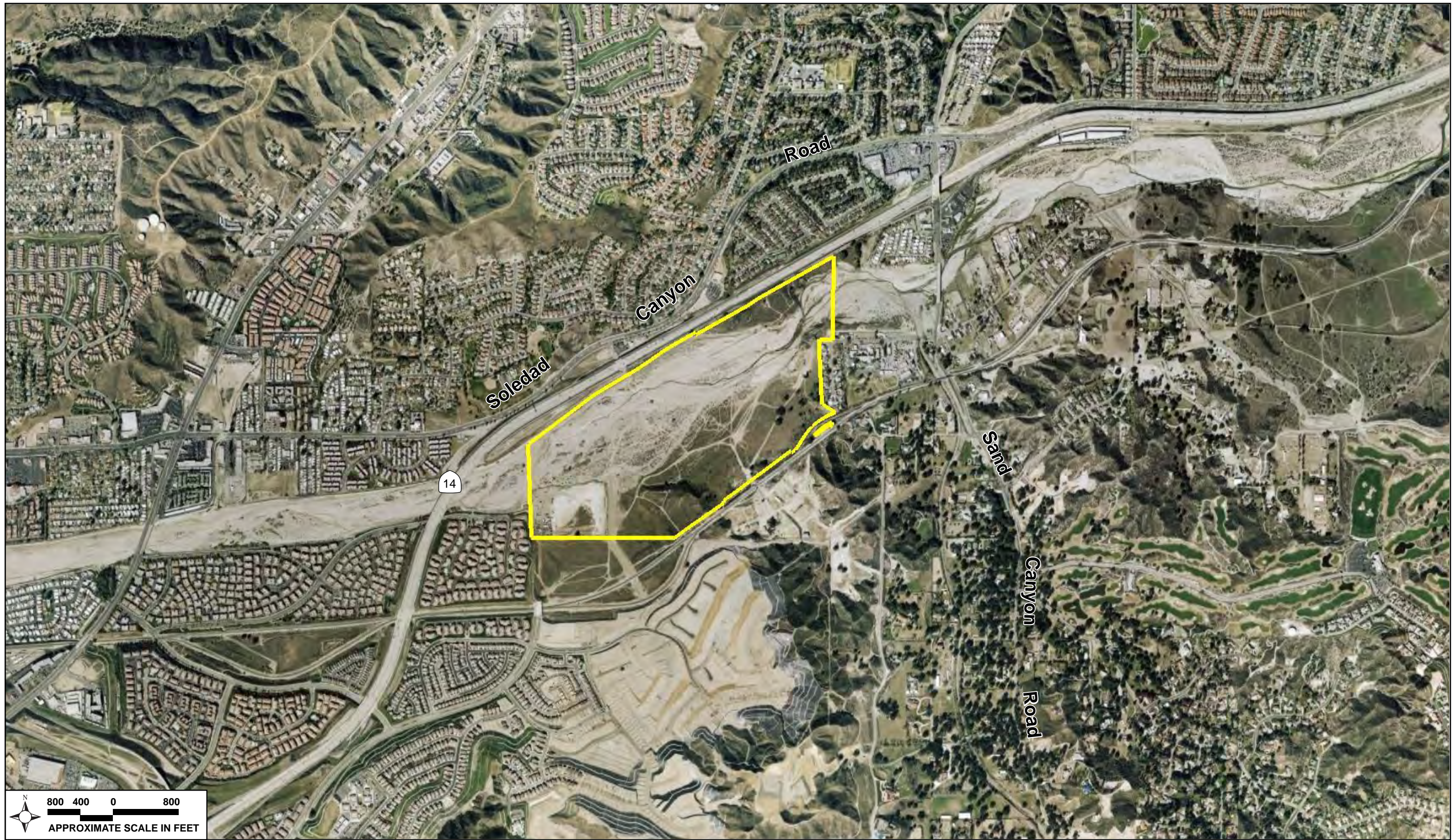

Figure 1.0-3

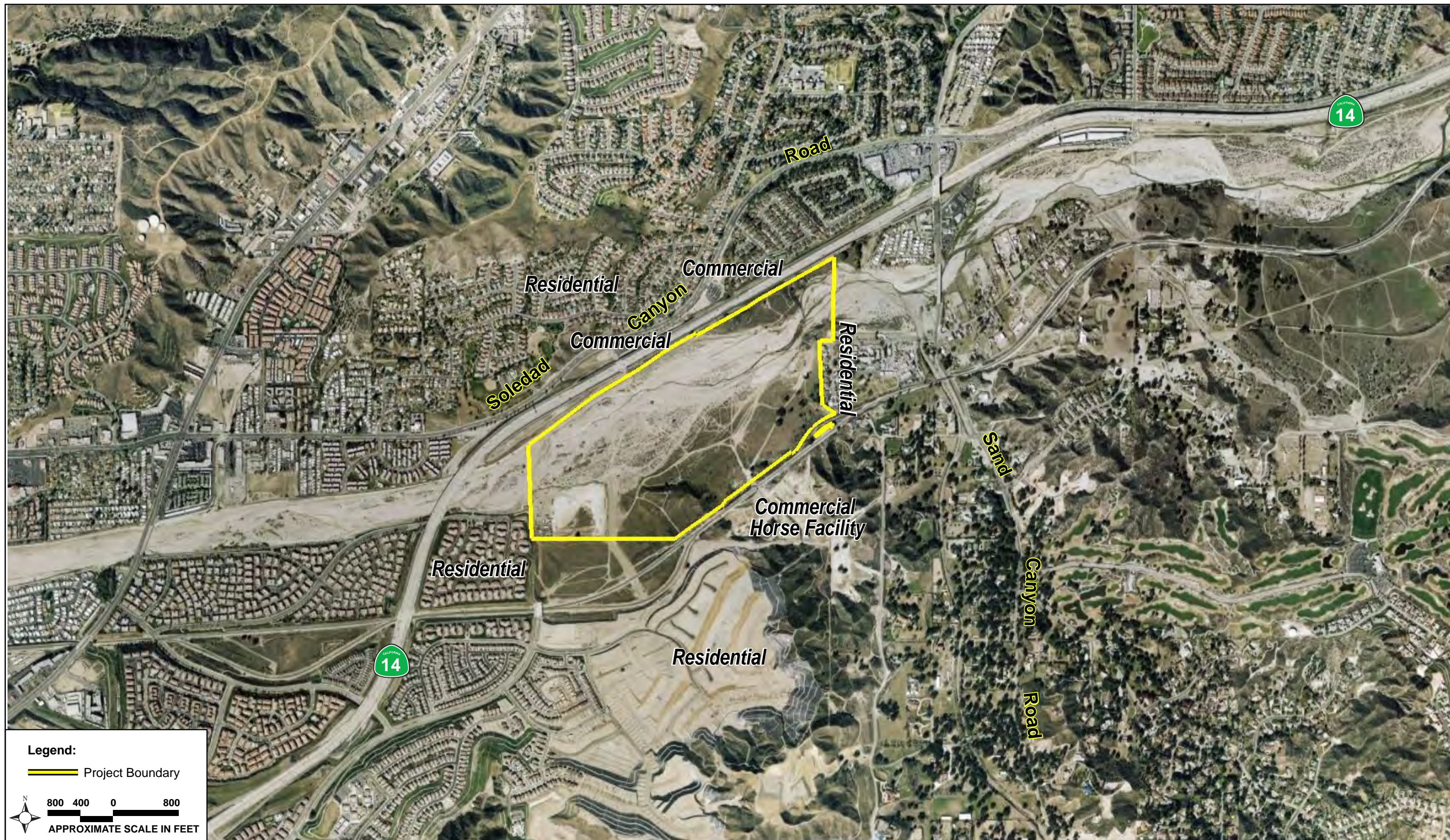

Figure 1.0-4

Vista Canyon Ranch, LLC, owns approximately 142 acres of the 185-acre site, with the City of Santa Clarita owning the remaining 43 acres. Most of the City's property is within the Santa Clara River Corridor. The project applicant would purchase a portion of the City's property (approximately four acres), based upon its appraised value. The City would also grant the applicant temporary and permanent easements within other portions of its land for the construction of buried bank stabilization, the Vista Canyon Road Bridge, and other project-related improvements. Additionally, remaining portions of the City property within the River Corridor would be enhanced by the Specific Plan. Upon completion of all improvements, the applicant shall dedicate, in fee and at no cost to the City, the applicant's River Corridor property (including the Mitchell Hill Open Space), which combined with the City's holdings will total approximately 87 acres.

The Specific Plan site also includes two Santa Clarita Water Division potable water wells located on a small parcel owned in fee by the Castaic Lake Water Agency, Santa Clarita Water Division. Implementation of the Specific Plan would result in the removal of one of the two wells.

Existing roadways provide access to the Specific Plan site. From the west is Lost Canyon Road, which presently terminates just beyond the Metrolink rail right-of-way. Access from the east also is provided by Lost Canyon Road, which presently terminates directly west of La Veda Avenue. The Specific Plan site is bordered by SR-14 to the north, and by the Metrolink rail right-of-way, a vacant 23-acre property, and the Fair Oaks Ranch community to the south.

The Specific Plan site is characterized by generally flat land on elevated terraces along both sides of the Santa Clara River, and a small knoll on the south side of the River. The site includes a reach of the Santa Clara River between Lost Canyon Road to the west and La Veda Avenue to the east, portions of which are under the jurisdiction of the U.S. Army Corps of Engineers (Corps) and the California Department of Fish and Game (CDFG). Surface flows within this portion of the Santa Clara River are seasonal, generally occurring during the winter months only after periods of heavy rainfall. Additionally, this portion of the River has been disturbed by various utility easements, which are maintained and operated across the River. Other activities have disturbed this portion of the River, including illegal dumping of trash and debris and unauthorized off-road vehicles. **Figure 1.0-5, Site Photographs**, illustrates the existing conditions within the Specific Plan area.

As noted above, the Specific Plan site is adjacent to the Metrolink rail right-of-way held by the Metropolitan Transit Authority (MTA) for Los Angeles County. This rail corridor includes the Metrolink Santa Clarita/Antelope Valley commuter line and freight service. Site constraints include the Santa Clara River Corridor and various utility easements. The site is irregularly shaped and includes elevated terraces along the Santa Clara River Corridor. These terraces drain towards the Santa Clara River. Existing site elevations range from a high of 1,555 elevation at the Mitchell Hill portion of the Specific Plan site to a low of 1,465 elevation in the middle of the Santa Clara River.

1.4 AUTHORITY

The Specific Plan has been prepared pursuant to the provisions of the California Government Code, Title 7, Division 1, Chapter 3, Article 8, sections 65450 through 65457. The California Government Code authorizes jurisdictions to adopt specific plans by resolution as policy documents or by ordinance as regulatory documents. The law allows preparation of specific plans, as may be required for the systematic execution of the General Plan and further allows for their adoption and amendment.

The Specific Plan is regulatory in nature and will serve as the zoning code for the Specific Plan site. The Specific Plan is prepared in accordance with SCMC, section 17.16.030, Specific Plan Zone. Section 17.16.030 includes adoption procedures, as well as requirements for Specific Plans to include use regulations, development regulations, performance standards, and amendment procedures. Development plans, tract maps, parcel maps and other entitlement requests processed in conjunction with the Specific Plan must be consistent with both the Specific Plan and the City's General Plan.

1.5 THE SPECIFIC PLAN'S RELATIONSHIP TO THE GENERAL PLAN, SANTA CLARITA MUNICIPAL CODE, AND OTHER LAWS

1.5.1 RELATIONSHIP TO THE GENERAL PLAN

The Specific Plan implements the goals and policies of the City's General Plan. **Appendix 1.0-2**, General Plan Consistency Analysis, contains an analysis of the Specific Plan's consistency with the City's General Plan. This analysis confirms that adoption of the Specific Plan is consistent with the General Plan. Additionally, an analysis was conducted relative to the Specific Plan's consistency with the City's proposed General Plan Update – One Valley One Vision (OVOV). This analysis confirms that adoption of the Specific Plan is also consistent with the proposed OVOV (see **Appendix 1.0-2**).

1.5.2 RELATIONSHIP TO THE SANTA CLARITA MUNICIPAL CODE

The Specific Plan will be incorporated into the SCMC and provide the allowable land uses, development regulations, design guidelines, and implementation procedures for the property within the boundary of the Specific Plan.

The regulations contained within the Specific Plan are in addition to those set forth in the planning, zoning, and subdivision provisions of the SCMC, and do not convey any rights not otherwise granted under the provisions and procedures contained in the SCMC or other ordinances, except as specifically provided for herein. Whenever the Specific Plan contains provisions that establish regulations, including, but not limited to, uses, densities, intensities, heights, parking, signage, open space, and landscaping requirements, which are different from, or more restrictive or permissive than would be allowed pursuant to the provisions of the SCMC, the Specific Plan shall prevail and supersede the applicable provisions of the SCMC.

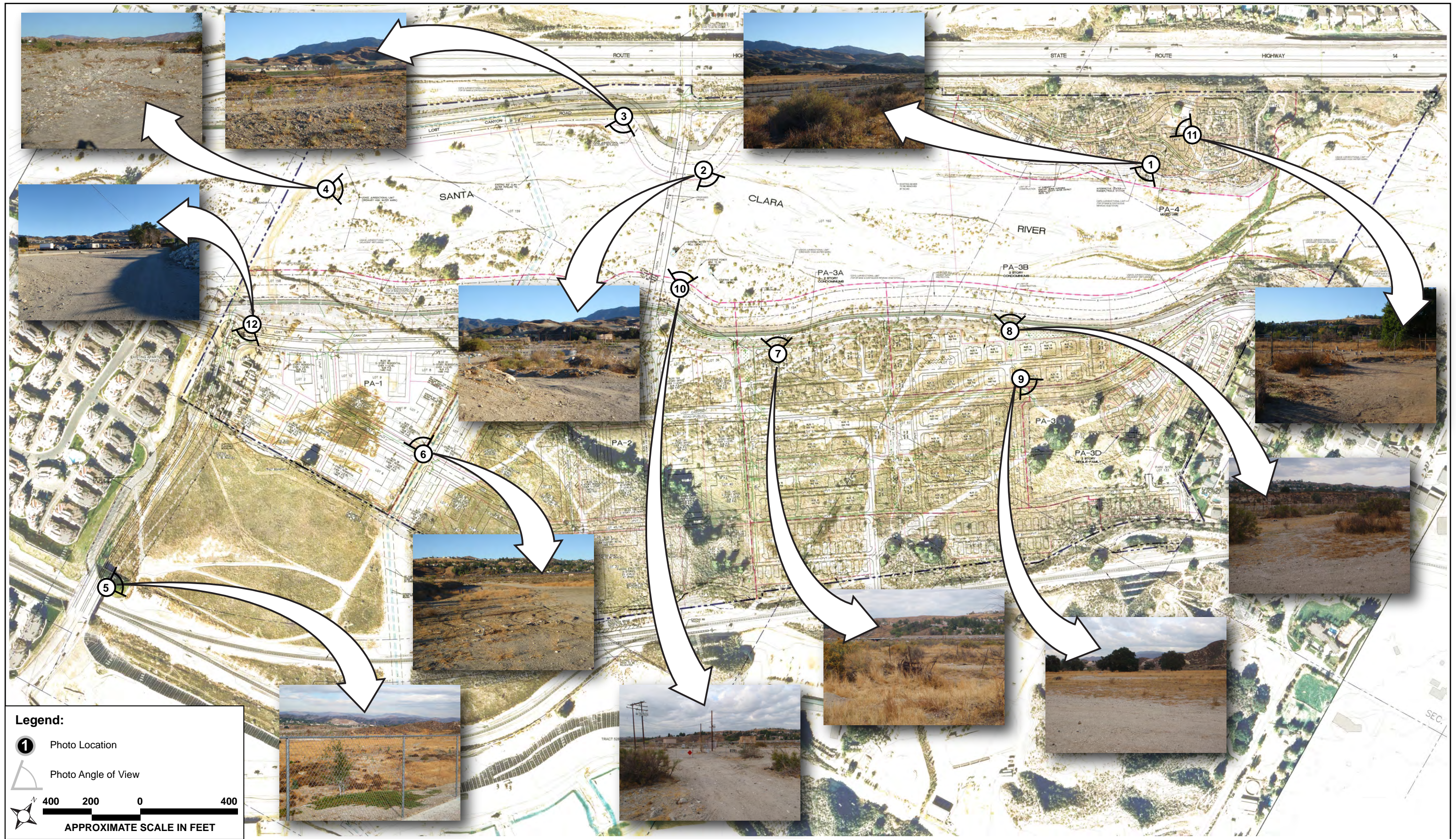

Figure 1.0-5

Site Photographs

1.6 COMPLIANCE WITH CALIFORNIA ENVIRONMENTAL QUALITY ACT

The City has prepared, as part of a comprehensive and open planning and environmental review process, an Environmental Impact Report (EIR) in accordance with the California Environmental Quality Act (CEQA). The EIR addresses the environmental implications of the Specific Plan and associated project approvals. The EIR also identifies feasible mitigation measures to reduce significant environmental impacts, and assesses a reasonable range of project alternatives.

1.7 COMPLIANCE WITH OTHER LAWS AND REGULATIONS

1.7.1 GLOBAL WARMING SOLUTIONS ACT OF 2006 (AB 32)

In 2006, the California Legislature enacted the California Global Warming Solutions Act of 2006. Also known as Assembly Bill 32 (AB 32), the new law designates the California Air Resources Board (CARB) as the state agency responsible for monitoring and regulating sources of greenhouse gas (GHG) emissions and for devising rules and regulations that will achieve the maximum technologically feasible and cost-effective GHG emissions reductions. Specifically, the new law seeks to achieve a reduction in statewide GHG emissions to 1990 levels by 2020, and sets forth a timeline for the adoption of measures to evaluate and reduce GHG emissions across all source categories. Significant among the actions included in the timeline are the requirements that CARB: (a) adopt regulations, to be enforced by January 1, 2010, to implement "early action measures" to reduce GHG emissions; and (b) adopt additional regulations, effective January 1, 2012, to achieve the GHG emissions reduction goals established by the new law.

The Specific Plan includes a sustainability plan that will achieve GHG emissions reductions resulting from implementation of the Specific Plan, consistent with this new law. The sustainability plan also includes energy, water, water quality, and landscaping components to improve overall efficiency and conservation.

1.7.2 TRANSPORTATION PLANNING AND PROGRAMMING (SB 375)

The California Legislature passed Senate Bill 375 (SB 375) on September 1, 2008, and SB 375 was signed by Governor Schwarzenegger and chaptered into law on September 30, 2008. In order to achieve the greenhouse gas reduction goals set forth in AB 32, SB 375 focuses on reducing vehicle miles traveled and urban sprawl.

Accordingly, SB 375 requires CARB, working in consultation with the local metropolitan planning organizations (MPO), here, the Southern California Association of Governments (SCAG), to set regional GHG emission reduction targets for the automobile and light truck sector for 2020 and 2035. Following state and local agency coordination efforts, CARB adopted reduction targets for each MPO on September 23, 2010. The target must now be incorporated by the MPO into that region's Regional Transportation Plan (RTP), which is used for long-term

transportation planning, through preparation of a Sustainable Communities Strategy (SCS). Certain transportation planning and programming activities would need to be consistent with the SCS; however, SB 375 also provides that the SCS does not regulate the use of land, and further provides that local land use plans and policies (e.g., general plan) are not required to be consistent with either the RTP or SCS.

SB 375 includes CEQA streamlining and/or exemption provisions for "transit priority projects" and other mixed-use or residential projects, so long as the projects are consistent with the SCS. As defined in SB 375, a "transit priority project" must: (a) contain at least 50 percent residential use, based on total building square footage and, if the project contains between 26 and 50 percent nonresidential uses, a floor area ratio of not less than 0.75; (b) provide a maximum net density of at least 20 dwelling units per acre; and (c) be within 0.5 mile of a major transit stop or high quality transit corridor. Inclusion of these CEQA streamlining and/or exemption provisions is intended to encourage the type of smart growth (e.g., infill; high density) that many believe is necessary to curb the growth of California's GHG emissions. While not a "transit priority project," as defined, the Specific Plan is considered a unique transit-orientated development due to its proximity to the existing Metrolink commuter rail line, site design, and commitment to development of a new Metrolink/City transit center and associated facilities.

1.7.3 ENERGY EFFICIENCY STANDARDS (TITLE 24)

The Energy Efficiency Standards for Residential and Nonresidential Buildings (Title 24), found in the California Code of Regulations, originally were established in 1978 in response to a legislative mandate to reduce California's energy consumption. Title 24 governs energy consumed by the built environment for commercial and residential buildings in California. This includes the HVAC system, water heating, and some fixed lighting. (Non-building energy use, or "plug-in" energy use, is not covered by Title 24.) The Title 24 standards are updated periodically to allow consideration and possible incorporation of new energy efficiency technologies and methods. The California Energy Commission (CEC) adopted a new set of standards on April 23, 2008, and the California Building Standards Commission approved them for publication on September 11, 2008. The 2008 standards went into effect on January 1, 2010, such that all applications for building permits submitted after that date will be subject to the 2008 standards.

Title 24 does not specify building dimensions (e.g., size, height, or orientation) and provides significant flexibility for window types, window amounts, insulation choice, and other parameters. Software often is used to calculate whether a building is Title 24 compliant by quantifying the built-environment energy use per square foot per year and the Time Dependent Valuation (TDV) of the energy use per square foot per year.² Title 24 compliance is based on TDV and not on annual energy use.

² TDV energy use is a parameter that speaks to the electricity burden that a building puts on the electric system. In general, there is a larger demand on the electricity supply system during the day (peak

As provided in the Vista Canyon Sustainability Plan, buildout of residential and non-residential uses under the Specific Plan would exceed the 2008 Title 24 standards by 20 percent, install Energy Star appliances (where available), and produce or purchase renewable electricity equivalent to the installation of an 80,000 square foot photovoltaic rooftop power system on residential or non-residential buildings.

Also of note, in early January 2010, the California Building Standards Commission unanimously adopted the first-in-the-nation mandatory statewide green building code - referred to as, CALGREEN. Effective January 1, 2011, these comprehensive regulations will achieve major reductions in GHG emissions, energy consumption, and water use to create a greener California. CALGREEN requires that every new building constructed in California reduce water consumption by 20 percent, divert 50 percent of construction waste from landfills, and install low pollutant-emitting materials. It also requires separate water meters for nonresidential buildings' indoor and outdoor water use, with a requirement for moisture-sensing irrigation systems for larger landscape projects and mandatory inspections of energy systems (e.g., heat furnace, air conditioner and mechanical equipment) for nonresidential buildings over 10,000 square feet to ensure that all are working at their maximum capacity and according to their design efficiencies.

times) than at night (off peak). This results in a higher stress on the electricity delivery system per marginal unit electricity delivered at peak times. Therefore, the calculation of TDV weights energy used at different times at different values. For instance, for the same annual electricity use, a building that uses more electricity during the peak mid-day electrical usage period will have a higher TDV value.

2.1 INTRODUCTION

The Specific Plan is designed to deliver a premier mixed-use, transit-oriented neighborhood to the eastern Santa Clarita Valley. The Specific Plan is guided by the goal of creating a unique, environmentally sensitive neighborhood where people can live, work, play, and shop. The Specific Plan reflects the rich heritage of the site and retains the character of the surrounding area while bringing a new vibrant mixed-use neighborhood to the community.

The size of the Specific Plan site provides a unique opportunity to plan an integrated neighborhood that balances the environmental sensitivity of the Santa Clara River with the opportunity to create a “town center” for this portion of the Santa Clarita Valley. This design concept is intended to maximize walkability and encourage day-to-day interaction between the mix of land uses within the Specific Plan. The Specific Plan also is committed to parks, recreation, and open space, and includes trails and the preservation of important river resources in and along the Santa Clara River.

The Specific Plan's design includes a new multi-modal transit hub, entailing a Metrolink Station, commuter platform, parking, Bus Transfer Station, and accessory improvements, to facilitate transit and reduce automobile trips. The multi-modal hub is enhanced further by an integrated, extensive network of trails and pedestrian connections, including two significant extensions of the Santa Clara River Trail.

In addition, the Specific Plan creates a one-of-a-kind opportunity for new employment in the eastern Santa Clarita Valley with premier office, retail, and live/work uses integrated within a street system oriented around a "Main Street" (Vista Square). A diversity of housing types will be provided, in conjunction with a proposed trail system and public and private parks connecting to Vista Square and the new City/Metrolink transit center. The Specific Plan will make significant on- and off-site roadway improvements to facilitate access to and from the subject property.

Upon buildout, the Specific Plan will allow a maximum of 1,100 residential dwelling units; up to 950,000 square feet of commercial and office, retail, theater, restaurant, and hotel uses; and open space, parks, trails, public and private street system, utilities, and associated amenities.

2.2 SPECIFIC PLAN OBJECTIVES

The Specific Plan's design is based on the following land use planning, economic, and resource conservation objectives:

2.2.1 LAND USE PLANNING OBJECTIVES

- (1) Create a new transit-orientated community with interrelated neighborhoods that allows for residential, retail/commercial, office, hotel, and recreational uses, while preserving and enhancing significant natural and historical resources.
- (2) Provide a sensitive and protective interface with the Santa Clara River Corridor by utilizing appropriate setback, grading, landscape, buried bank stabilization, and water quality treatments.
- (3) Provide development and transitional land use patterns that do not conflict with surrounding communities and land uses.
- (4) Arrange land uses to reduce vehicle miles traveled and energy consumption, and to encourage the use of transit.
- (5) Design neighborhoods to create a unique identity and sense of place.
- (6) Design neighborhoods to locate a variety of residential and non-residential land uses in close proximity to each other and major road corridors, transit, and trails.
- (7) Provide a rich set of public spaces, including roadways that range from lively streetscapes to pedestrian passages.
- (8) Implement sustainable development principles, including greater energy efficiency, waste reduction, drought-tolerant landscaping, use of water efficiency measures, and use of recycled materials and renewable energy sources.
- (9) Create and enhance opportunities for non-vehicular travel and encourage pedestrian mobility by providing an internal pedestrian circulation system that links residential neighborhoods to nearby schools, neighborhood parks, trail systems, neighborhood retail/commercial and adjacent park and recreation areas.
- (10) Foster the design and integration of a mutually beneficial relationship between the natural and built environments, and implement sensitive land use transition treatments, attractive streetscapes, and high quality design themes.
- (11) Provide a meandering trail with public access adjacent to the Santa Clara River Corridor.
- (12) Integrate a new community into the City's existing and planned circulation network.
- (13) Provide a landscape design that emphasizes a pleasant neighborhood character and inviting streetscapes.

- (14) Facilitate the expansion of transit facilities by providing property and participate in the funding of a new City/Metrolink transit center and associated facilities, and direct pedestrian access to such facilities from the Specific Plan's commercial, retail, office, and residential areas.
- (15) Provide neighborhood parks and improvements that offset park dedication requirements and meet the recreation needs of local residents.

2.2.2 ECONOMIC OBJECTIVES

- (1) Enhance and augment the housing market by providing a variety of housing types and densities to meet the varying needs of future residents.
- (2) Adopt development regulations that provide flexibility to respond and adjust to changing economic and market conditions.
- (3) Provide a tax base to support public services and infrastructure.
- (4) Provide a project jobs/housing balance of at least two jobs for every one residential unit.
- (5) Adopt development regulations and guidelines that allow site, parking and facility sharing, and other innovations that reduce the costs of providing public services.

2.2.3 RESOURCE CONSERVATION OBJECTIVES

- (1) Restore and minimize impacts to important biotic resources.
- (2) Maintain the use of the Santa Clara River as a major east/west open space corridor.
- (3) Establish a Santa Clara River Corridor and adopt measures to maintain, enhance, and protect important river habitat values and functions.
- (4) Provide native revegetation of river and setback areas when temporarily disturbed due to development activities.
- (5) Minimize impacts to the Santa Clara River and its resources.
- (6) Minimize impacts to oak trees and incorporate, where possible, oak trees into public spaces.

2.3 LAND USE PLAN

The Specific Plan's objectives, above, guide the overall Land Use Plan. The Land Use Plan (**Figure 2.0-1**) and the Specific Plan Summary (**Table 2.0-1**) provide the framework for development of the Specific Plan area. This section establishes the Specific Plan's land use

designations by Planning Area and uses/acreage. **Table 2.0-2, Land Use Plan Statistical Summary**, also is provided to show the Land Use Plan statistical summary broken down by Planning Area and land use designation (Residential (R), Mixed-Use (MU), Open Space (OS), and Other (O)), all of which are linked by a system of trails, public streets, and private drives.

This zoning approach differs from conventional zoning, which typically divides areas into zones that rigidly segregate residential, commercial, and non-residential uses into distinct areas, and thereby require residents to drive for nearly all daily activities.

**Table 2.0-1
Specific Plan Summary**

Planning Area No.	Commercial Square Footage	Office Square Footage	Dwelling Units	Other Land Uses	Acreage
Planning Area-1 (PA 1)	n/a	n/a	480	Water Reclamation Plant, Private Drives, Private Recreation Areas, Landscape Areas, Trails	11.5
Planning Area-2 (PA 2)	164,000 sf retail plus a 200-room hotel (140,000 sf)	646,000	325	Metrolink and Bus Transfer Stations, Vista Square, Community Garden, Town Green, Private Recreation Areas, Trails	32
Planning Area-3 (PA 3)	n/a	n/a	295	Oak Park/River Education Center, Private Recreation Area, Trails, Landscape Areas	40.8
Santa Clara River Corridor	n/a	n/a	n/a	River Corridor, Mitchell Hill Open Space	87.3
Public Streets	n/a	n/a	n/a	n/a	13.7
TOTAL	164,000 sf plus a 200-room hotel (140,000 sf)	646,000	1,100		185.3

Notes:

The Specific Plan allows for a transfer of up to 81 residential units from PA-2 to PA-3 and the transfer of up to 74 residential units from PA-3 to PA-2; however, in no event shall the project be permitted to exceed a maximum of 1,100 residential units.

Source: Tentative Tract Map No. 69164 (April 2011).



Figure 2.0-1

**Table 2.0-2
Land Use Plan Statistical Summary**

Planning Areas	Land Use Designation ¹	Use Type	Acres (gross)	Dwelling Units	Square Footage		
					Retail	Office	Hotel
PA-1	R	Attached Residential, Private Recreation Areas	10.5	480	--	--	--
	O	Water Reclamation Plant	1	-	-	-	-
PA-2	MU	Offices, Retail, Hotel, ² Theater, Parking Structures (including Metrolink Parking), Residential, Private Recreation Areas	30	325	164,000	646,000	140,000
	O	Community Garden, Town Green, Metrolink and Bus Transfer Stations	2	-	-	-	-
PA-3	R	Attached and Detached Residential, Private Recreation Area	30	295	--	--	--
	O	Oak Park	10.8	--	--	--	--
Other Areas							
River Corridor (including Mitchell Hill Open Space)	OS	River	87.3	--	--	--	--
Public Streets	O	Streets	13.7	--	--	--	--
TOTAL			185.3	1,100	164,000	646,000	140,000

Notes:

¹ R = Residential; MU = Mixed Use; OS = Open Space; and O = Other. OS includes the Santa Clara River Corridor, including buried bank stabilization areas.

² PA-2 includes a four-story hotel/s with 200 rooms, as shown on Tentative Tract Map No. 69164.

Source: Tentative Tract Map No. 69164 (April 2011)

2.3.1 LAND USE DESIGNATION ZONES*

The following land use designation zones are established by this Specific Plan, and are applied to property within the Specific Plan area, as shown on the Specific Plan Land Use Plan (Figure 2.0-1):

1. **Residential (R).** The R land use designation zone is applied to areas appropriate for a variety of attached and detached residential units, including condominiums, apartments, residential flats, attached residential with surface parking, and attached residential with parking structure. The R designation includes for rent and for sale units. The designation also allows recreation, trails, landscaped areas, and parking areas to support the residential areas.
2. **Mixed-Use (MU).** The MU land use designation zone is applied to areas appropriate for a wide-range of land uses, and allows multi-family residential, office, retail, and general commercial uses, and office over retail, hotel/lodging, theatre, cinema or performing arts, studios, health/fitness facilities, churches, child care facilities, community assembly, and outdoor dining. Civic uses also are encouraged in this zone. Street frontages in the MU zone are pedestrian-oriented, and parking structures, surface parking and subterranean parking are allowed. Further, this zone contemplates a variety of office uses, including areas appropriate for business, financial, professional, business support service, processing, administrative, bank, medical services, and other office and supporting uses. This zone will accommodate local and regional employment needs and enhance the Specific Plan's housing/employment balance objectives. This zone also contemplates a variety of retail uses, including areas appropriate for restaurant, café, coffee shop (including outdoor seating), market, general retail, food service (including drive-through facilities), and entertainment.
3. **Open Space (OS).** The OS land use designation zone is applied to the Santa Clara River Corridor, including the Mitchell Hill Open Space, buried bank stabilization areas and the Santa Clara River Trail.
4. **Other (O).** The O land use designation zone is applied to areas containing public facilities, streets, and recreation areas. Areas covered by the O designation include the water reclamation plant, Oak Park, public streets, Metrolink Station, Bus Transfer Station, Community Garden, River Education Center and Town Green.

2.3.2 PLANNING AREAS

The Specific Plan site is to be developed in three Planning Areas, as shown on Tentative Tract Map No. 69164. The Planning Areas are described below.

Planning Area 1 (PA-1). PA-1 consists of approximately 11.5 acres located within the southwest portion of the Specific Plan site. This area consists of a maximum of 480 attached, multi-family condominium units, which may be sold or leased. Three private recreational areas (0.39 acre), trails, water quality improvements, surface and structure parking, and other open areas also are provided within PA-1. The water reclamation plant also is located in PA-1. The maximum building height in PA-1 is 50 feet (excluding architectural elements, which can extend up to a maximum of 60 feet). Building footprints, building locations, multi-family product types shown on TTM 69164 within PA-1 can be modified consistent with the requirements of the Specific Plan.

Planning Area 2 (PA-2). PA-2 consists of approximately 32 acres, located within the south central portion of the Specific Plan site. PA-2 consists of 325 attached, residential condominium units (*e.g.*, apartments, live/work units, residential flats, residential over retail), and two private recreation areas. All of the residential units in PA-2 may be leased. Up to 81 of the 325 residential units within PA-2 can be transferred to PA-3. In addition, PA-2 includes 646,000 square feet of office space; 164,000 square feet of retail space (including restaurants and a theater); a 200-room hotel/s (consisting of approximately 140,000 square feet); up to four parking structures and accessory surface and subterranean parking; the multi-modal transit hub, consisting of the Metrolink Station and Bus Transfer Station; Vista Square-Pedestrian Plaza; Town Green; Community Garden; and associated park, trails, swales, private drives, and public streets. Recreational areas, trails, water quality improvements, and other open areas also are provided within PA-2. The Town Green and Community Garden would be maintained by a property owners' association. The maximum height in PA-2 for retail/commercial buildings is 55 feet (excluding architectural elements, which can extend up to a maximum height of 66 feet). Excluding architectural elements, the maximum height for the two office buildings in PA-2 located adjacent to the Lost Canyon Road/Vista Canyon Road intersection is 95 feet, and 60 feet for office buildings located south of these two office buildings. Architectural elements could extend up to 114 feet and 72 feet, respectively. All residential structures within PA-2 will have a maximum height of 50 feet (excluding architectural elements, which would extend up to 60 feet). PA-2 includes a unique mix of office, retail, and residential uses with a street system oriented around "Main Street" (Vista Square), "Plaza at Vista Square," and the theater. Vista Square includes diagonal on-street parking, sidewalks, landscaping, public amenities (*e.g.*, benches, bike racks, and outdoor dining), and other traffic calming features to balance the needs of pedestrians with those of cars, and to enable pedestrian-oriented shops, restaurants, and services. This vibrant area also is in close proximity to the multi-modal transit hub to facilitate transit, reduce automobile trips, and create a place to live, work, play, and shop.

Building footprints and land uses shown on TTM 69164 within PA-2 can be modified or relocated consistent with the requirements of the Specific Plan.

Planning Area 3 (PA-3). PA-3 consists of approximately 40.8 acres, located within the southeast portion of the Specific Plan site. PA-3 consists of up to 295 residential units, which can be either single-family or multi-family attached units. Up to 74 of the 295 residential units in PA-3 can be transferred to PA-2. The maximum height of the residential structures within PA-3 is 35 feet. The 10.8-acre Oak Park/River Education Center within PA-3 is to be improved and dedicated to the City, while the private park and recreation facilities (1 acre) are to be utilized by future residents and maintained by a homeowners' association. Trails, water quality improvements, and other open areas also are provided within PA-3. To support the residential uses within PA-3, the area also includes one public street (Lost Canyon Road) and private streets/drives.

Building footprints, building locations, multi-family and single-family product types shown on TTM 69164 within PA-3 can be modified and relocated consistent with the requirements of the Specific Plan. **Other Areas.** The Specific Plan includes other areas within its boundary. These areas include: (a) the buried bank stabilization/protection along the north and south side of the Santa Clara River; (b) the reach of the Santa Clara River Corridor (including the Mitchell Hill Open Space) within the Specific Plan boundary; and (c) the public streets and private drives in and out of the Specific Plan site.

2.3.3 OFF-SITE IMPROVEMENTS

To facilitate development of the Specific Plan, the applicant is responsible for the grading and construction of off-site improvements. The off-site improvements consist of:

- (a) The extension of Lost Canyon Road (approximately 800 feet), from its present terminus at the northerly abutment of the bridge over the Metrolink railroad tracks within Fair Oaks Ranch, across adjacent properties to the Specific Plan site. The right-of-way for this road is proposed at 95 feet, which will accommodate two vehicular lanes in each direction, a raised landscaped median, parkway, sidewalk, and Class III bike lanes. Approximately 160,000 cubic yards of grading is necessary to complete this improvement.
- (b) The extension of Jakes Way (approximately 250 feet) from its present terminus directly west of the Specific Plan site to the proposed roundabout at Lost Canyon Road and Jakes Way. The right-of-way for this road is proposed at 92 feet, which will accommodate one vehicular lane in each direction, parkway, sidewalk, and Class III bike lanes. Approximately 2,000 cubic yards of grading is necessary to complete this improvement. Buried bank stabilization also is necessary along this roadway extension, and will connect to the existing concrete-gunite flood protection located directly north of the existing Jakes Way.

- (c) Grading on portions of the adjacent properties to the south for slope and drainage purposes.
- (d) The extension of the Santa Clara River Regional Trail easterly from the Specific Plan site will either be constructed along the Santa Clara River at a width of 12 feet (assuming necessary easements can be acquired) or along Lost Canyon Road at a width of up to 10 feet from the project boundary to Sand Canyon Road. The trail will consist of decomposed granite or a similar surface and include a pedestrian/equestrian bridge crossing over the Sand Canyon Wash.
- (e) The widening and completion of roadway improvements on Lost Canyon Road under SR-14, within the existing right-of-way. This roadway presently is partially improved and used for public access. Proposed improvements would include the addition of pavement, curb gutter, and sidewalk (east side).
- (f) The import of up to 500,000 cubic yards of dirt from one or both of the following borrow sites: (a) the George Carvalho Santa Clarita Sports Complex; and/or (b) the Centre Pointe Business Park. Development on both of the borrow sites previously has been approved by the City of Santa Clarita.
- (g) Construction of the platform and accessory station improvements within the Metrolink right-of-way as part of a new multi-modal transit hub.
- (h) Grading and various trail improvements within the Metrolink right-of-way adjacent to the site.
- (i) Construction of various off-site roadway infrastructure improvements.

2.4 MOBILITY PLAN

2.4.1 INTRODUCTION

The Specific Plan's Mobility Plan provides for a transportation/circulation system utilizing existing routes and new facilities. The Mobility Plan incorporates vehicular and non-vehicular modes of transportation in a system of roads, bike lanes, trails, and pedestrian pathways. Roads are arranged in a hierarchy, organized by function, to facilitate access within and around the Specific Plan site. The Plan seeks to implement street sections that slow traffic and create a pleasant walking environment and reduce urban "heat island" effect.³ The Specific Plan's

³ The term "heat island" describes built environment areas that are hotter than nearby rural or open areas. Heat islands can affect communities by increasing summertime peak energy demand, air conditioning costs, greenhouse gas emissions, heat-related illness and mortality, and water quality. (See <http://www.epa.gov/heat island/index.htm>, last visited April 8, 2011.)

circulation network described below is conceptually shown on **Figure 2.0-2, Specific Plan Circulation Network**.

The Specific Plan also is guided by its proximity and access to the existing Metrolink rail right-of-way, located adjacent to the southern boundary of the Specific Plan site. Traditionally, these rights-of-way were viewed as "constraints" to proposed development. However, today, planning principles recognize that commuter rail lines and transit stations can be more than travel nodes because a segment of the community wants the option of riding the train or utilizing transit to travel to and from work, combined with the vitality that tends to surround such transit-oriented areas. Proximity to transit reduces automobile trips and creates a place to live, work, play, and shop.

Consistent with these planning principles, the Specific Plan proposes to provide the land needed to develop a new multi-modal transit hub within PA-2 and partner with the City and MTA on the related facilities. The Mobility Plan creates and enhances opportunities for non-vehicular travel and pedestrian mobility by facilitating transit with the new City/Metrolink transit center and directing pedestrian access to such facilities from the Specific Plan's office, commercial, retail, hotel, and residential areas.

The Specific Plan's other key feature consists of a mix of office, commercial, retail, and residential uses surrounded by a Main Street thoroughfare (Vista Square), which, like the rest of the project, is designed as a pedestrian-oriented environment. This town center design is intended to calm traffic in order to balance the needs of pedestrians to those with cars, and to enable pedestrian-oriented shops, restaurants, and services. The design concept for "Vista Square" is to create a feeling that people are at the center of an exciting and dynamic place with sidewalk dining, shops, traffic-calming features, and streetscape improvements. Parking along Vista Square is addressed through diagonal on-street parking, along with other parking in PA-2 in the form of strategically located "park-once" parking structures in close proximity to Vista Square.

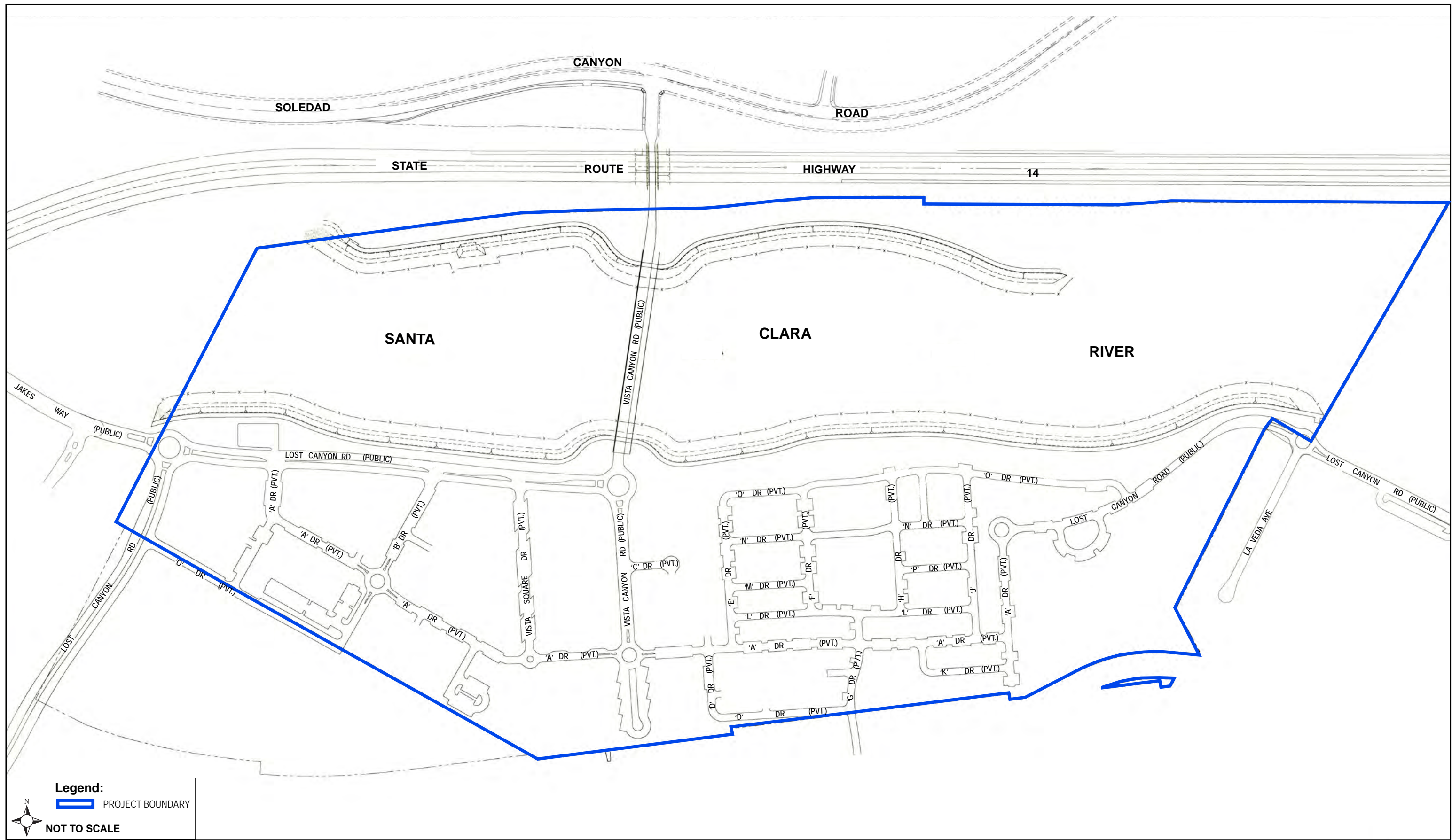

Figure 2.0-2 Specific Plan Circulation Network

2.4.2 EXISTING REGIONAL CIRCULATION AND ACCESS

The City is served by an existing network of highways, roadways, multi-use trails, commuter rail, and transit service. Primary regional access in the Santa Clarita Valley is provided by I-5, located south and west of the Specific Plan site. SR-14, located north of the Specific Plan site, also provides a regional link between the Los Angeles basin and the high desert communities of Palmdale and Lancaster. SR-14 connects to I-5 southwest of the Specific Plan site. Soledad Canyon Road provides secondary regional access, paralleling SR-14 along the northern boundary of the Specific Plan site and extending north to Palmdale and Lancaster.

The Metrolink Antelope Valley line serves the region by connecting the Antelope Valley with points south, including Santa Clarita, to Union Station in downtown Los Angeles. The City also presently is served by a City-owned and operated bus service. Santa Clarita Transit (SCT) provides local and regional bus service, operating local routes within the Santa Clarita Valley and regional routes to and from Los Angeles, Antelope Valley, Van Nuys, and Warner Center. The Los Angeles Department of Transportation (LADOT) also provides commuter service with stops in the Santa Clarita Valley.

The Specific Plan will connect to the Santa Clarita backbone trail network as well as the County of Los Angeles trail system.

2.4.3 LOCAL ROADWAY CIRCULATION AND ACCESS

The Specific Plan Mobility Plan roadway network is designed as an orderly extension of the existing regional circulation pattern in the Santa Clarita Valley. The proposed development patterns within the Specific Plan site, integrated with existing and proposed roadway alignments, form the basis for this network. The Mobility Plan is designed to integrate modes of travel, accommodate anticipated traffic demands generated by the Specific Plan and surrounding development, and provide important roadway extensions and improvements that ultimately will connect existing and proposed Planning Areas to the SR-14 corridor and the rest of the Santa Clarita Valley.

Vehicular access to and from the Specific Plan site will be from four existing roadways. Primary access to the site will be from: (a) Soledad Canyon Road, via the new Vista Canyon Road Bridge, to the north; (b) the westerly Lost Canyon Road within Fair Oaks Ranch, which will be extended to the Specific Plan site, connecting with Jakes Way at a roundabout; (c) Jakes Way, which would be extended easterly from its present terminus to Lost Canyon Road; and (d) after the Lost Canyon Road/Jakes Way roundabout, Lost Canyon Road will traverse easterly through the Specific Plan site and terminate at a roundabout with the new Vista Canyon Road. Secondary access to and from the Specific Plan site will be from the easterly terminus of Lost Canyon Road near existing La Veda Avenue; this access is designed with a roundabout, an internal traffic loop, and other traffic calming features to minimize "cut-through" traffic.

Additionally, the Specific Plan will include improvements to Lost Canyon Road from La Veda Avenue to Sand Canyon Road. These improvements will consist of constructing a trail within the right-of-way on the north side of Lost Canyon Road (if not located along the River) and striping Lost Canyon Road to include two travel lanes and an auxiliary lane, which will provide for vehicle stacking in front of both schools. Additionally, intersection improvements, consisting of a single-lane “roundabout” will be constructed at the intersection of Lost Canyon Road and Sand Canyon Road.

2.4.3.1 Lost Canyon Road

Lost Canyon Road from Via Princessa to Sand Canyon Road is the only roadway within the Specific Plan boundary designated as a "Major/Secondary Highway" in the Santa Clarita General Plan Circulation Element and the Los Angeles County Master Plan of Highways. Both the City and County anticipate Lost Canyon Road continuing through the Specific Plan site.

The project applicant is requesting a General Plan Amendment to the City's Circulation Element in order to:

- (a) Establish the Lost Canyon Road alignment;
- (b) Reduce Lost Canyon Road from a six-lane Major Highway to a four-lane Secondary Highway from its westerly terminus in Fair Oaks Ranch to the future roundabout at Lost Canyon Road and the proposed Vista Canyon Road;
- (c) Designate the Vista Canyon Road Bridge as a Limited Secondary Highway, with this roadway consisting of two travel lanes, a striped median/emergency lane, sidewalk and a Class I bike path on the east side; and,
- (d) Remove Lost Canyon Road, from Vista Canyon Road to Sand Canyon Road, from the City's General Plan Circulation Element as a Major Highway.

If the General Plan Circulation Element Amendments are adopted, the Specific Plan will implement the Mobility Plan shown on **Figure 2.0-3**. As shown, the following Lost Canyon Road segments will be constructed:

Lost Canyon Road South of Jakes Way

Lost Canyon Road will be extended (approximately 800 feet), from its existing terminus at the northerly abutment of the bridge over the Metrolink rail tracks within Fair Oaks Ranch, north across adjacent properties to the south and west of the Specific Plan site. This segment, a public street, will have a maximum 95-foot right-of-way and provide two vehicular lanes in each direction and raised medians, curbs and gutters, parkways, sidewalks and Class III bike lanes on both sides. This road is depicted in cross-section and plan view in **Figure 2.0-4**, below.

Roundabout "A": Lost Canyon Road at Jakes Way

This section of Lost Canyon Road will terminate on the west side of the Specific Plan site at a roundabout, located at Lost Canyon Road and Jakes Way (Roundabout "A"), as shown on Tentative Tract Map No. 69164. The roundabout's overall radius is 79 feet, and consists of two vehicular travel lanes. The plan view of this roundabout is depicted below in **Figure 2.0-5**.

Jakes Way/Lost Canyon Road (Lost Canyon Road to Vista Canyon Road)

Jakes Way will be extended (approximately 250 feet) from its existing terminus directly west of the Specific Plan site to the proposed roundabout at Lost Canyon Road and Vista Canyon Road. This segment, a public street, will have a maximum 92-foot right-of-way and provide vehicular lanes in each direction, raised medians, curbs and gutters, parkways, a sidewalk on one side and Class III bike lanes. Buried bank stabilization is needed along the north side of this roadway extension and will connect to the existing concrete-gunite flood protection located directly north of the existing Jakes Way. This road is depicted in cross-section and plan view in **Figure 2.0-6**, below.

Lost Canyon Road to La Veda Avenue

The portion of Lost Canyon Road located within PA-3 will be extended to the existing segment of La Veda Avenue to the east. This segment, a public street, will have a maximum 68-foot right-of-way and accommodate one vehicular lane in each direction, as well as parking, curbs and gutters, parkways, and sidewalks on both sides of the street, in addition to various traffic calming improvements. This road is depicted in cross-section and plan view in **Figure 2.0-7**, below.

Lost Canyon Road East of La Veda Avenue

Lost Canyon Road will be extended east of the existing La Veda Avenue segment beyond the easterly portion of the Specific Plan site. This segment, a public street, will have a maximum 66-foot right-of-way and accommodate one vehicular lane in each direction, a center stacking or left-turn lane, curbs and gutters, parking on the south side, a sidewalk on the south side in order to create a continuous walkway to Sand Canyon Road further east, and a trail on the north side (if not constructed along the River). This segment will provide access to the east side of the Specific Plan, serving primarily PA-3. This road is depicted in cross-section and plan view in **Figure 2.0-8**, below.

2.4.3.2 Vista Canyon Road

Vista Canyon Road/Vista Canyon Road Bridge (North)

At the Lost Canyon Road/Vista Canyon Road roundabout, Vista Canyon Road will traverse both north and south. The northerly portion of Vista Canyon Road will consist of two lanes in a maximum right-of-way width of 64 feet, with a painted median/emergency lane, curbs and gutters, and a Class I trail. This road will cross the Santa Clara River via the Vista Canyon Road Bridge. This road is depicted in cross-section and plan view in **Figure 2.0-9**, below.

Vista Canyon Road SR-14 Underpass to Soledad Canyon Road Improvements

Once on the north side of the Santa Clara River, Vista Canyon Road will continue to proceed north under SR-14 and ultimately connect to Soledad Canyon Road. As part of the Specific Plan, the applicant will widen and complete roadway improvements, within the existing City right-of-way, on Vista Canyon Road under SR-14. This roadway currently is partially improved and used for public access. Proposed improvements will include the addition of pavement, curbs, and gutters, and a sidewalk on the east side. This road is depicted in cross-section and plan view in **Figure 2.0-10**, below.

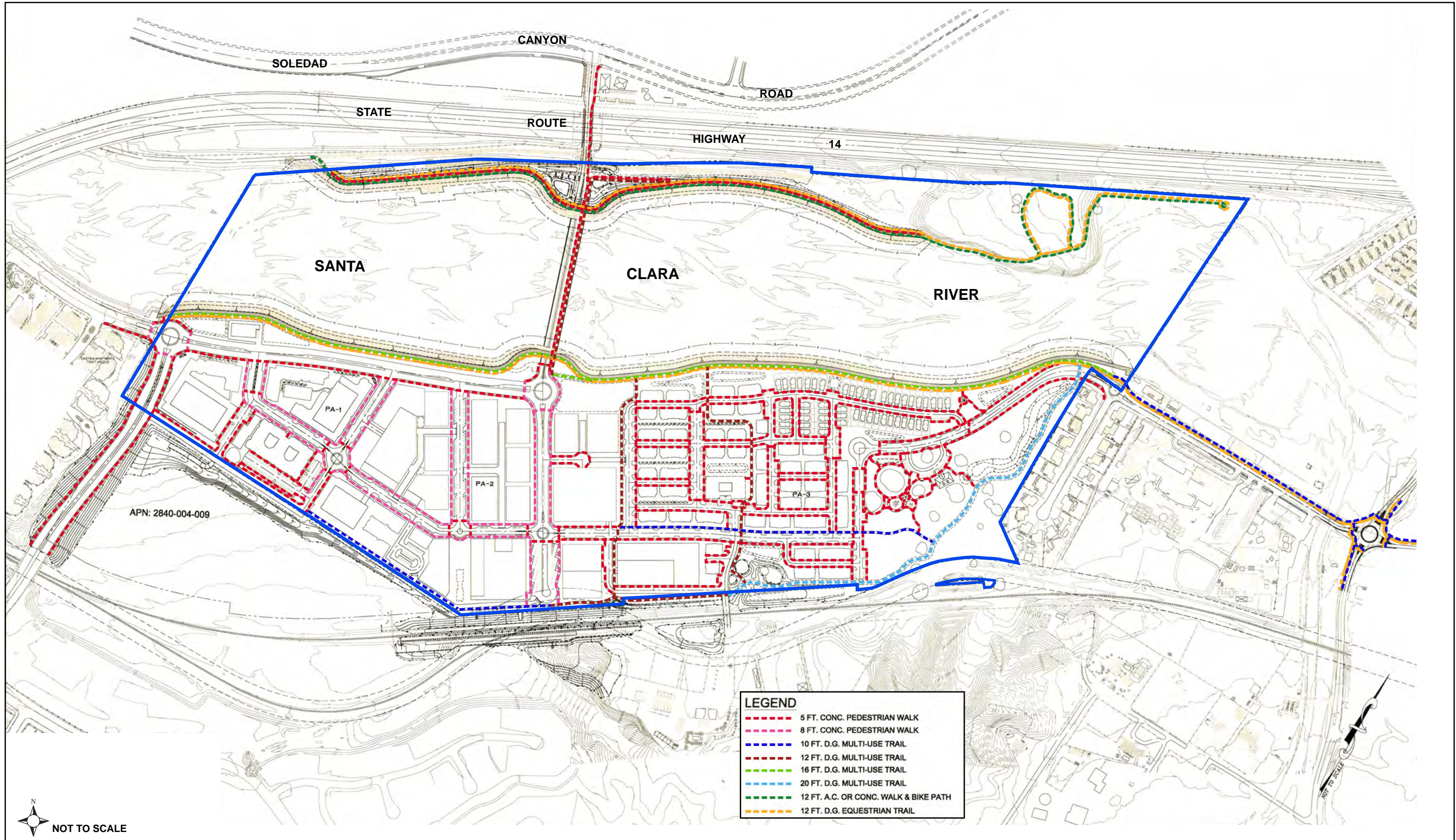
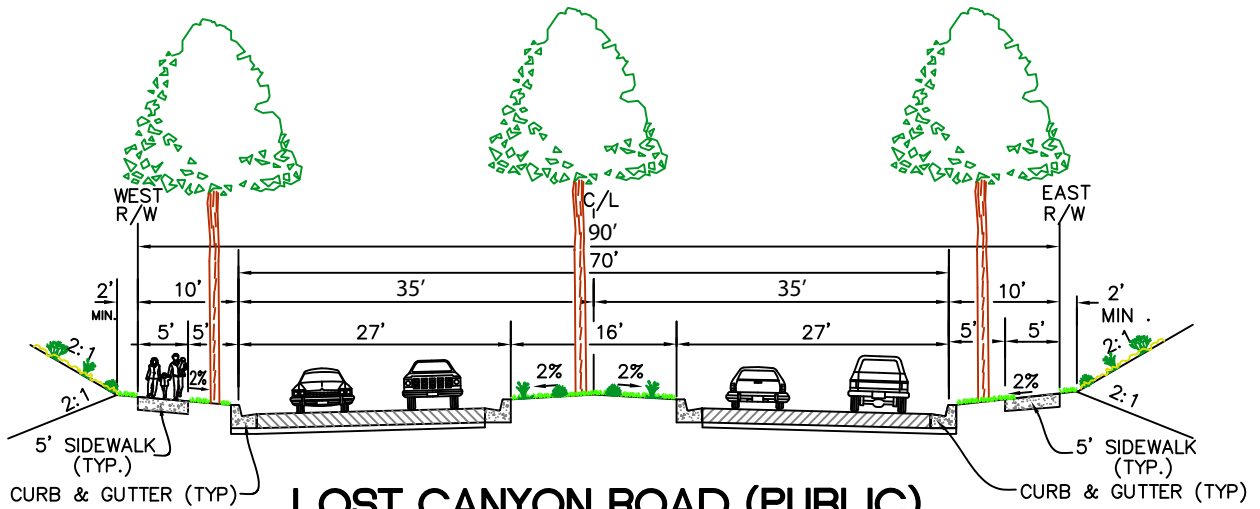
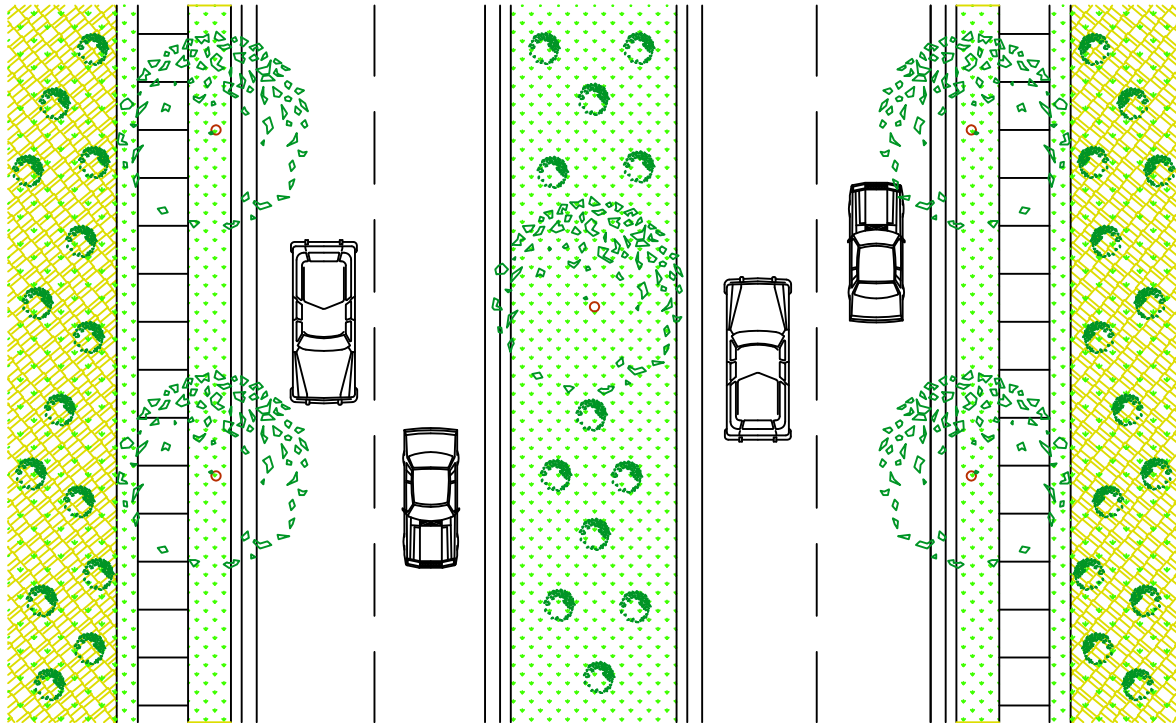

Figure 2.0-3



LOST CANYON ROAD (PUBLIC)
SOUTH OF JAKES WAY
CROSS SECTION

NOT TO SCALE



PLAN VIEW

NOT TO SCALE

NOT TO SCALE

Figure 2.0-4

Road Section (Lost Canyon Road South of Jakes Way)

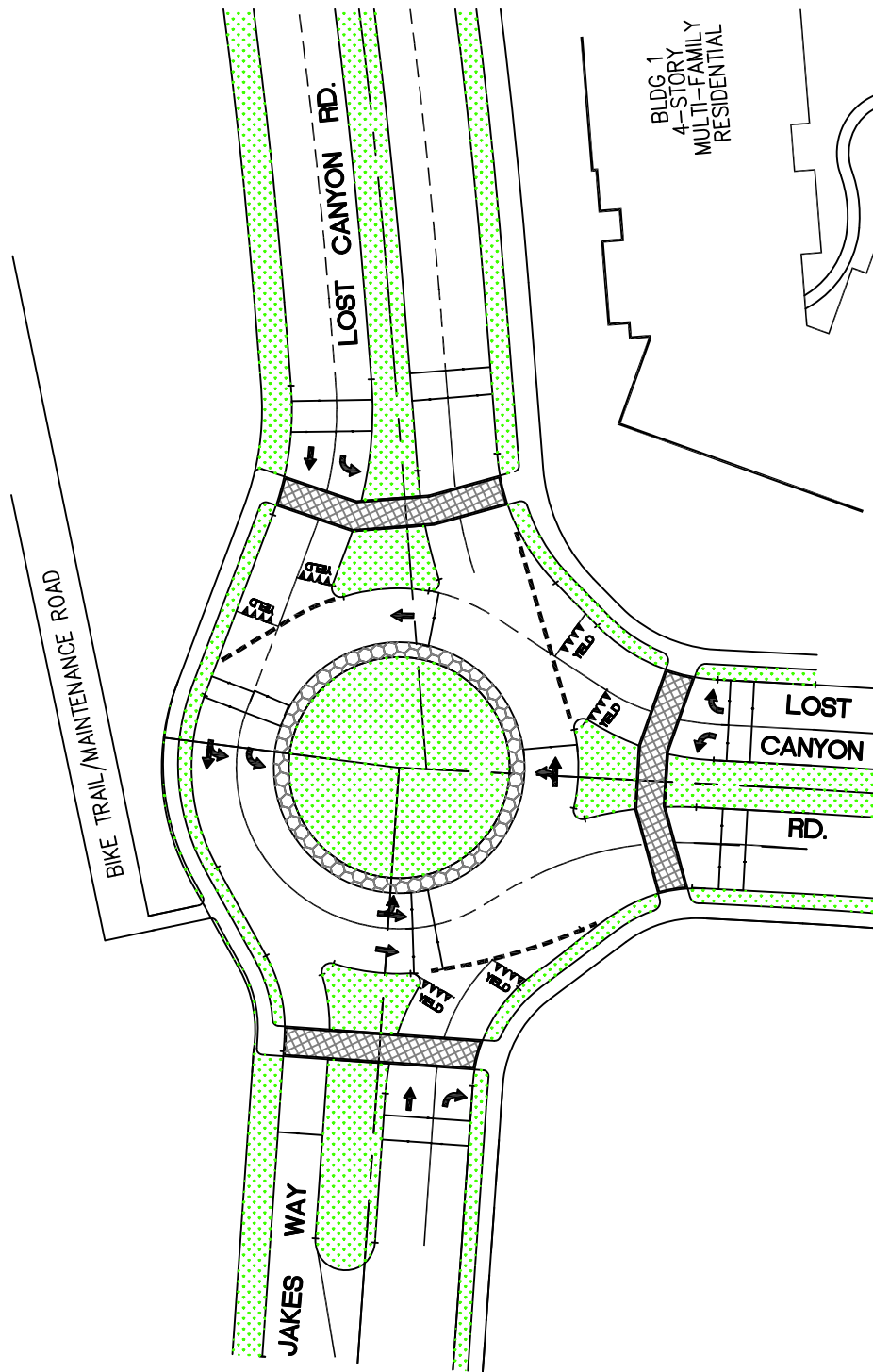

ROUNDABOUT 'A'
LOST CANYON ROAD at JAKES WAY

 NOT TO SCALE

Figure 2.0-5 Road Section (Roundabout "A": Lost Canyon Road at Jakes Way)

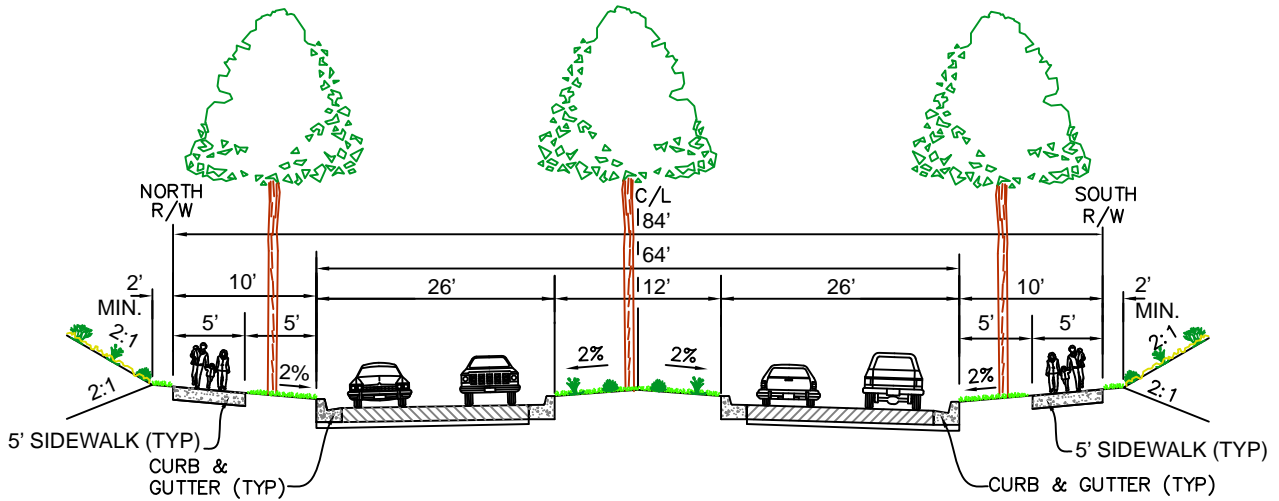

LOST CANYON ROAD (PUBLIC)
JAKES WAY TO VISTA CANYON ROAD

CROSS SECTION

NOT TO SCALE

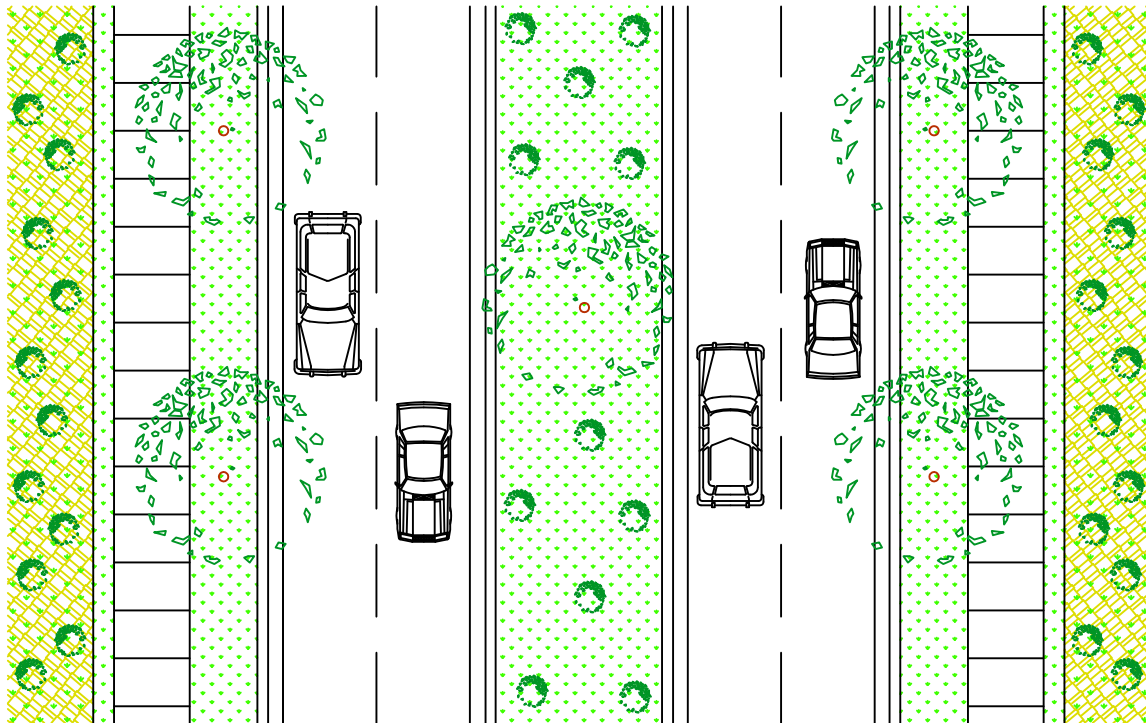

PLAN VIEW

NOT TO SCALE

NOT TO SCALE

Figure 2.0-6

Road Sections (Lost Canyon Road,
 Jakes Way to Vista Canyon Road)

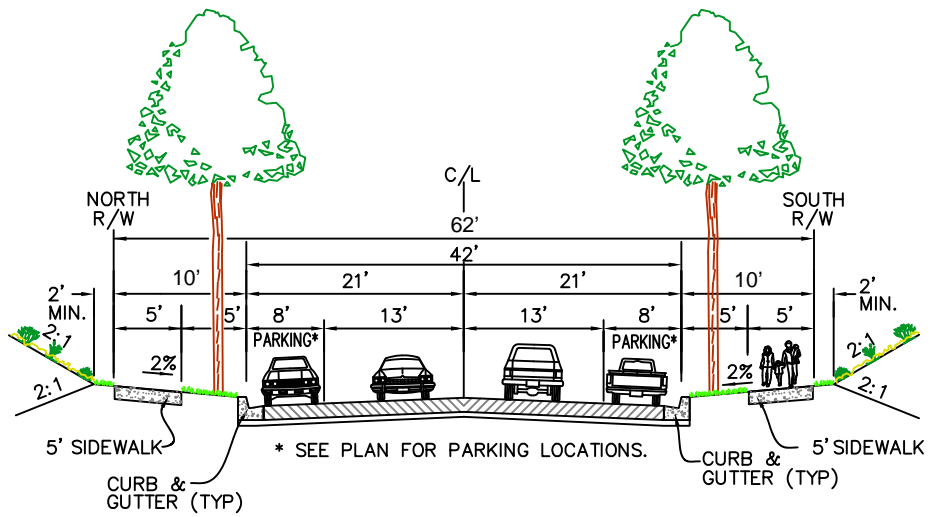

LOST CANYON ROAD (PUBLIC)
VISTA CANYON ROAD TO LA VEDA AVE.
CROSS SECTION
 NOT TO SCALE

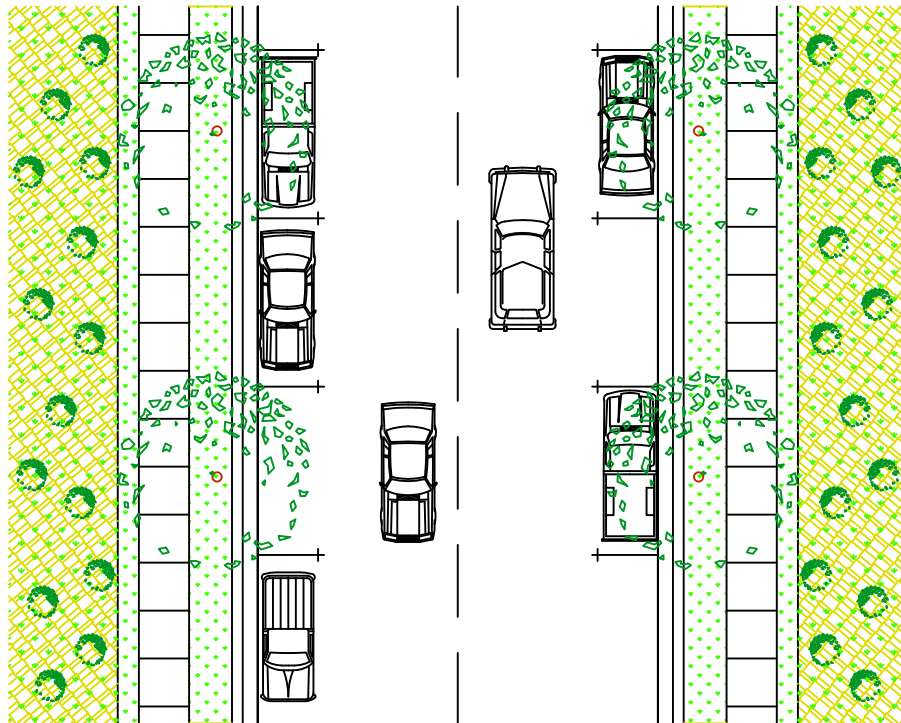

PLAN VIEW
 NOT TO SCALE

NOT TO SCALE

Figure 2.0-7

Road Sections (Lost Canyon Road to La Veda Avenue)

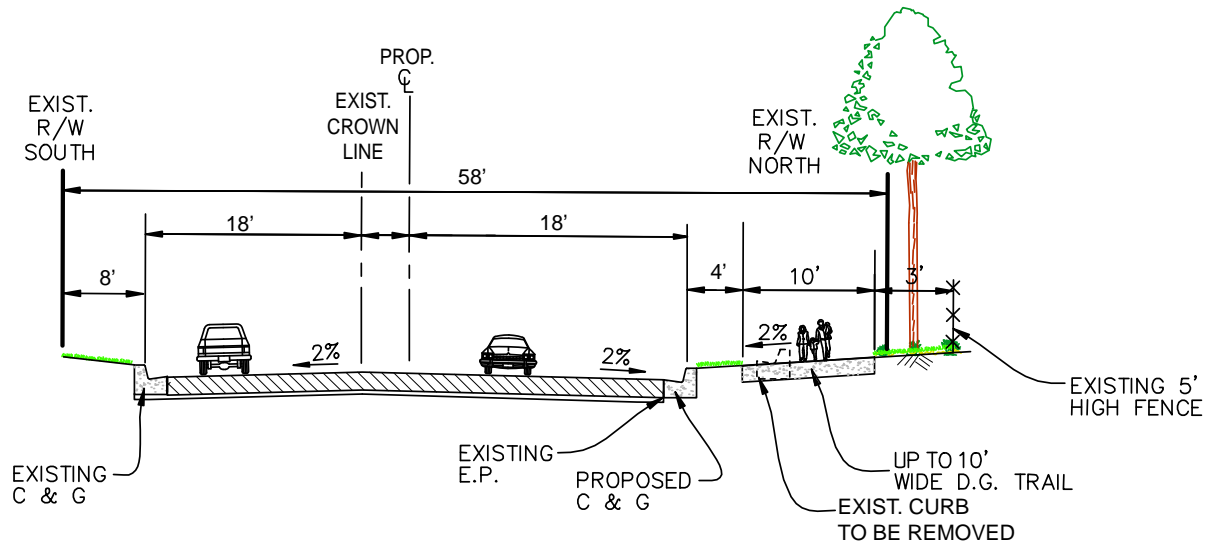

LOST CANYON ROAD SECTION B-B:

NOT TO SCALE

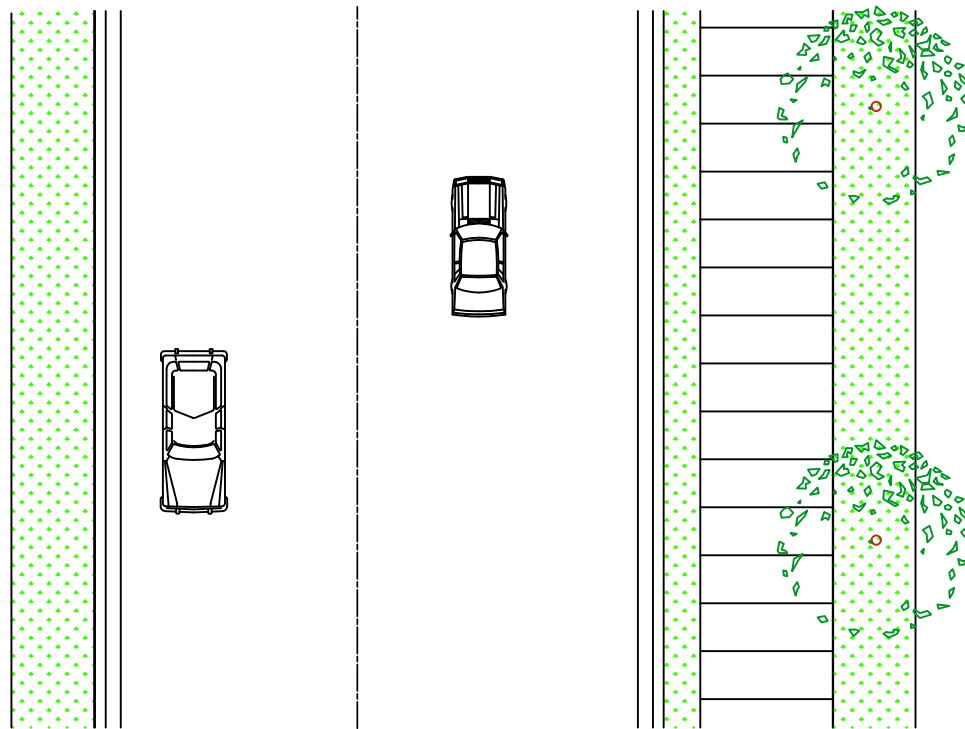

PLAN VIEW

NOT TO SCALE

NOT TO SCALE

Figure 2.0-8

Road Sections (Lost Canyon Road East of La Veda Avenue)

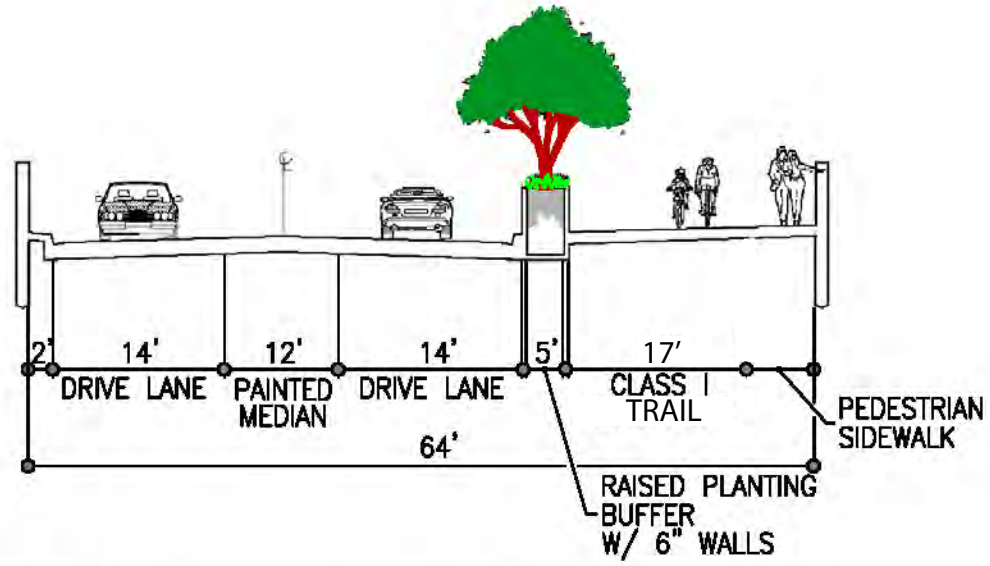

VISTA CANYON ROAD - BRIDGE (PUBLIC)
CROSS SECTION
 NOT TO SCALE

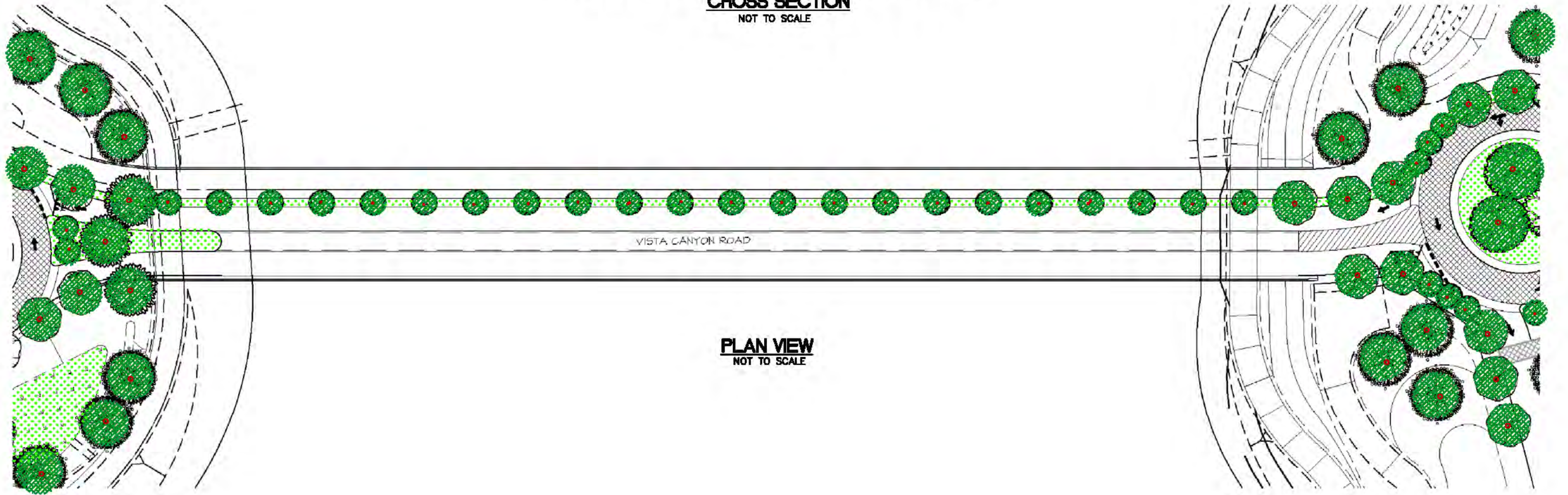

NOT TO SCALE

Figure 2.0-9

Road Sections (Vista Canyon Road/Vista Canyon Road Bridge – North)

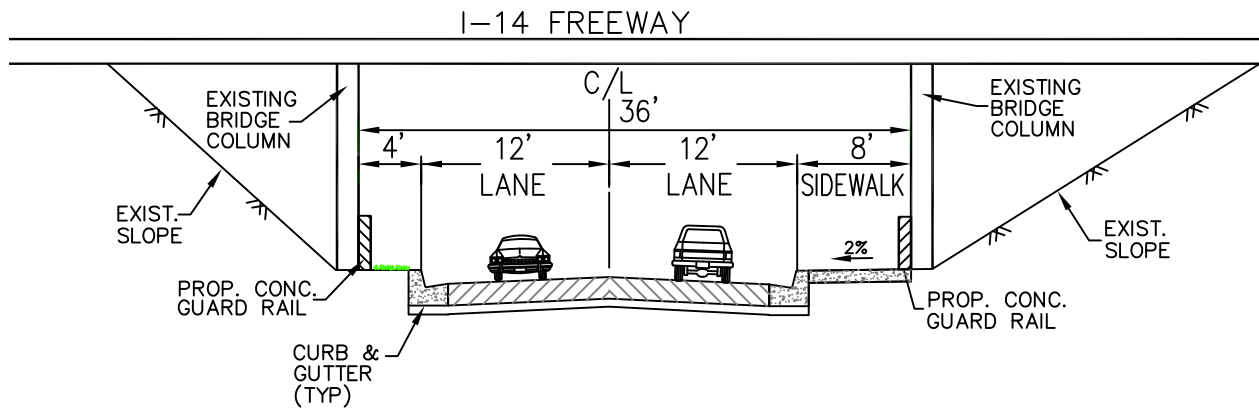

VISTA CANYON ROAD
I-14 UNDERPASS IMPROVEMENT DETAIL
CROSS SECTION
 NOT TO SCALE

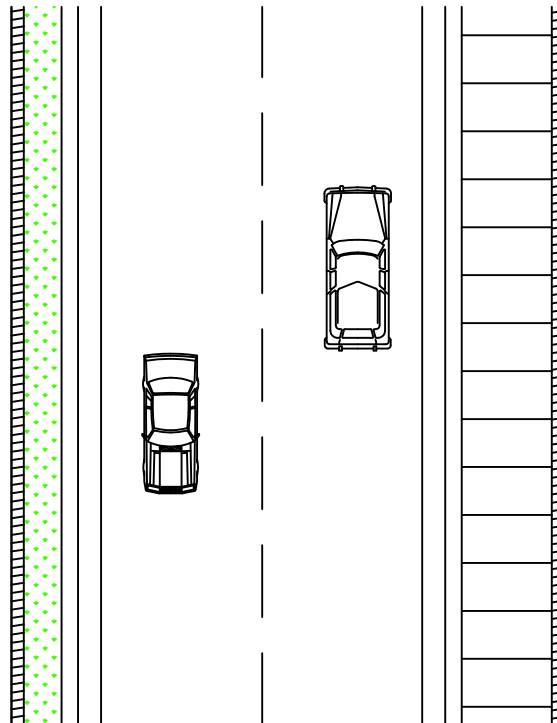

PLAN VIEW
 NOT TO SCALE

NOT TO SCALE

Figure 2.0-10

Road Sections (Vista Canyon Road SR-14 Underpass to Soledad Canyon Road Improvements)

Vista Canyon Road (South)

The southerly portion of Vista Canyon Road will be a two-lane public street with a maximum right-of-way width of 79 feet, painted median/left-turn lane, curbs and gutters, parkways, sidewalks and Class II bike lanes on both sides, and will traverse southeast through the Specific Plan site connecting to A Drive at a roundabout. This segment will serve primarily the office, hotel, retail, and residential live/work uses within PA-2. This road also will serve as the primary access point to the Metrolink and Bus Transfer Stations, park site, and parking structures in the eastern portion of PA-2. This road is depicted in cross-section and plan view in **Figure 2.0-11**, below.

The roundabout at Vista Canyon Road and A Drive will consist of two vehicular traffic lanes. The plan view of this roundabout is depicted in **Figure 2.0-12**, below.

2.4.3.3 Vista Square ("Main Street")

Vista Square Drive will be a two-lane, private street, and serve as the "Main Street" within PA-2 to facilitate traffic circulation, and also enable pedestrian-oriented shops, restaurants, and services. This private street will have a maximum 88-foot right-of-way with diagonal on-street parking and sidewalks on both sides, landscape parkway, curbs and gutters, and streetscape amenities (*e.g.*, benches, bike racks, and outdoor dining). This design is intended to facilitate traffic calming in order to balance the needs of pedestrians with those of cars. This road is depicted in cross-section and plan view in **Figure 2.0-13**, below.

2.4.3.4 Other Private Neighborhood Streets

The alignment, location, and design of the below listed private streets and drives may be modified or eliminated based upon final development plans.

A, B, and Q Drives

A, B, C, and Q Drives will be two-lane, private streets, and provide internal circulation for the office, hotel, commercial, retail, and residential land uses in PA-1 and PA-2. The private drives will have a maximum 64-foot right-of-way with parking, and parkways and sidewalks on both sides, and curbs and gutters. These private drives are depicted in cross-section and plan view in **Figure 2.0-14**, below.

C, D and G Drives

D and G Drives will be two-lane, private streets, and provide internal circulation for the residential uses in PA-3. These drives will have a maximum 28-foot right-of-way, and are depicted in cross-section and plan view in **Figure 2.0-15**, below.

E, F, H, I, J, K, L, M, N, O, and P Drives

These drives will be two-lane, private streets, and provide internal circulation for the residential land uses in PA-3. They will have a maximum 31-foot right-of-way, with curbs and gutters, as well as sidewalk on one side. These private drives are depicted in cross-section and plan view in **Figure 2.0-16**, below.

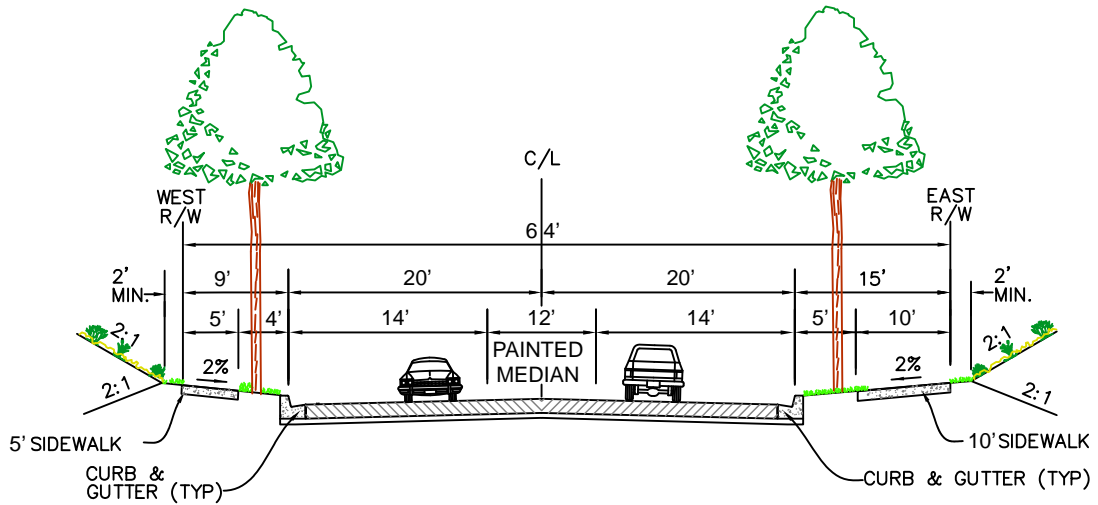

VISTA CANYON ROAD (PUBLIC)
CROSS SECTION
 NOT TO SCALE

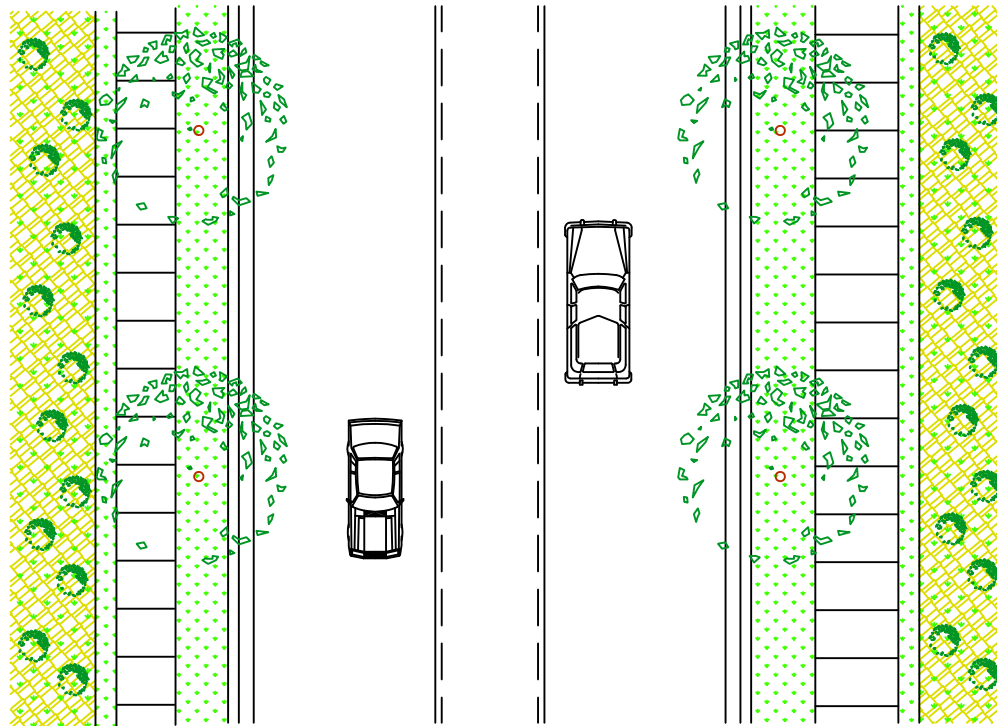

PLAN VIEW
 NOT TO SCALE

NOT TO SCALE

Figure 2.0-11

Road Sections (Vista Canyon Road – South)

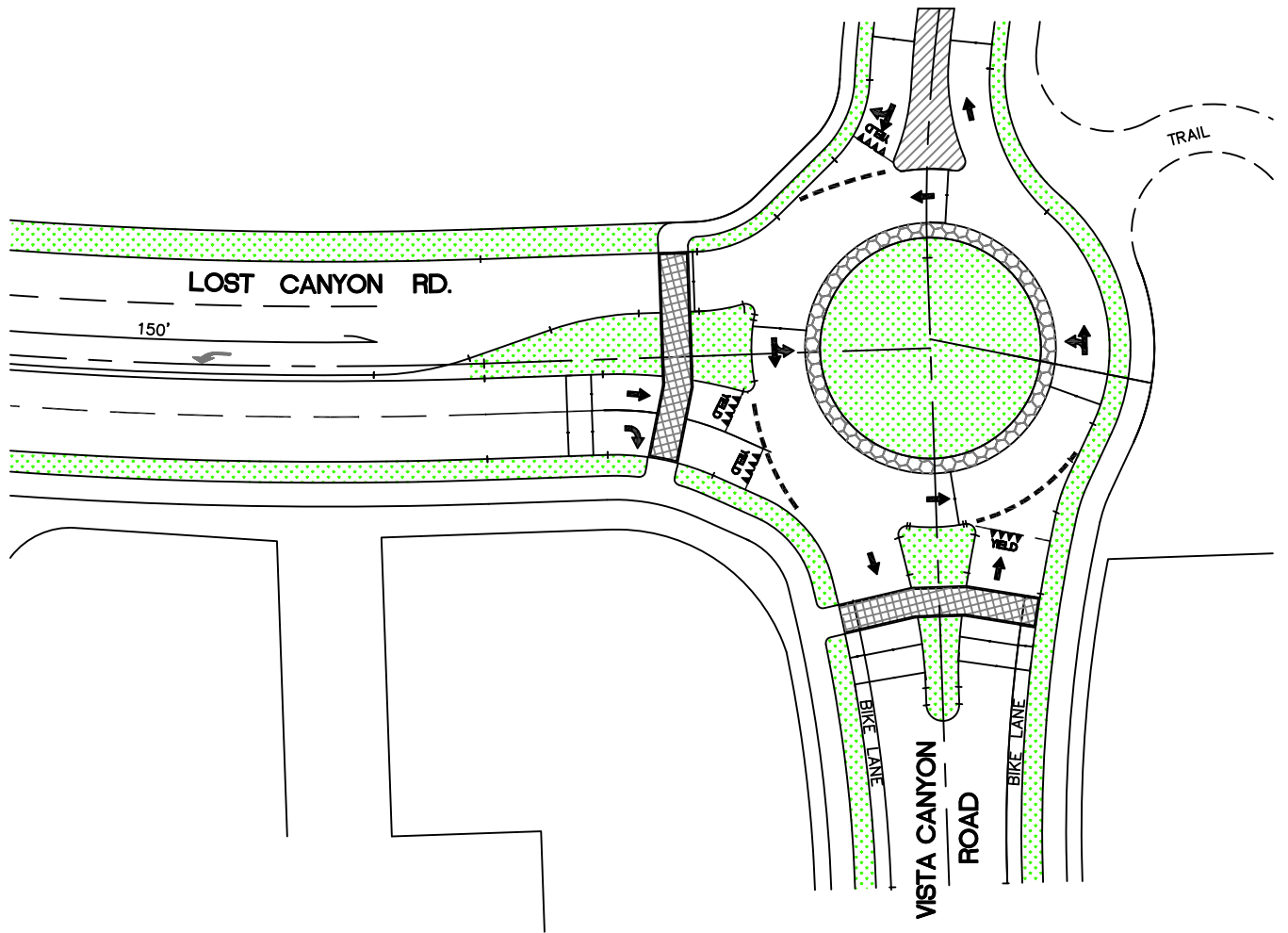

ROUNDABOUT 'B'
LOST CANYON RD AT VISTA CANYON RD.

NOT TO SCALE

Figure 2.0-12

Road Sections (Roundabout at Vista Canyon Road and Lost Canyon Road)

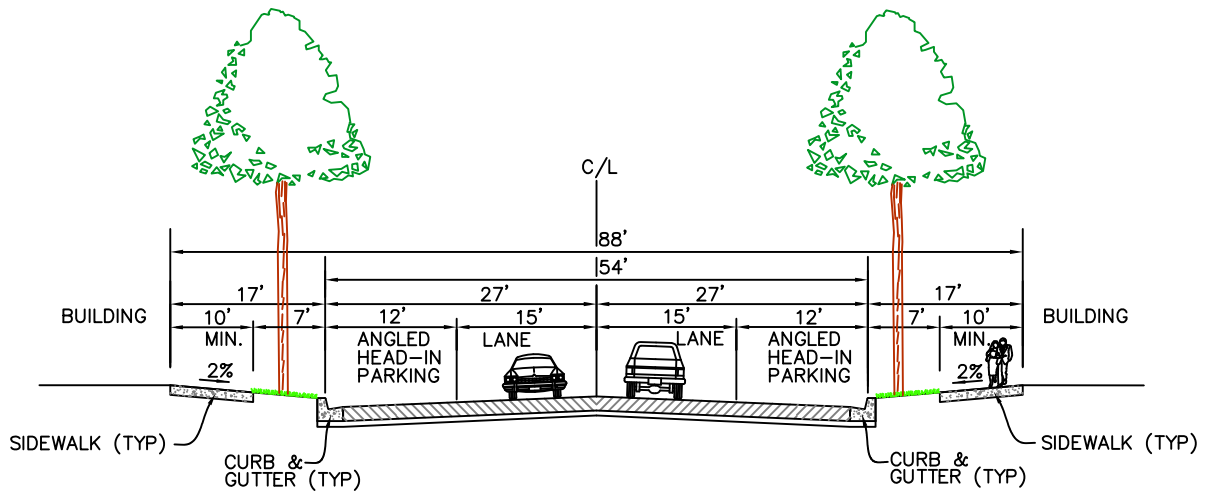

VISTA SQUARE DRIVE (PVT.)
NOT TO SCALE

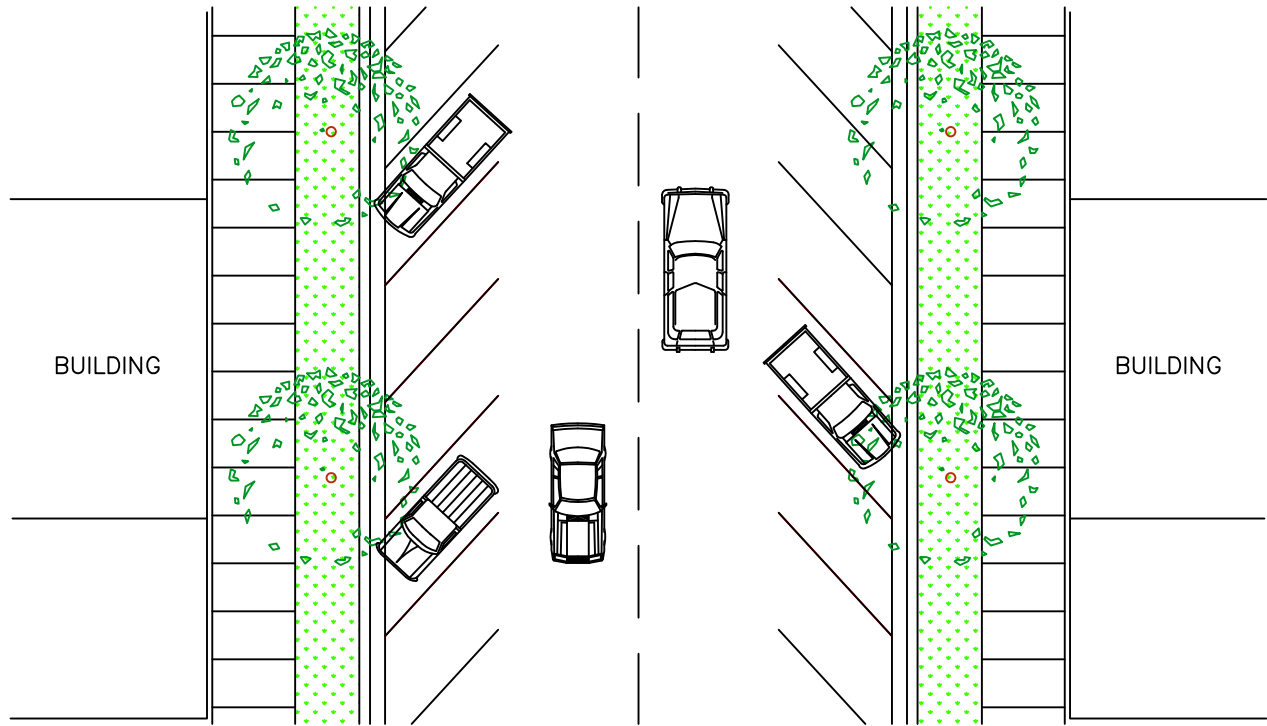

PLAN VIEW
NOT TO SCALE

NOT TO SCALE

Figure 2.0-13

Road Sections (Vista Square Drive – Main Street)

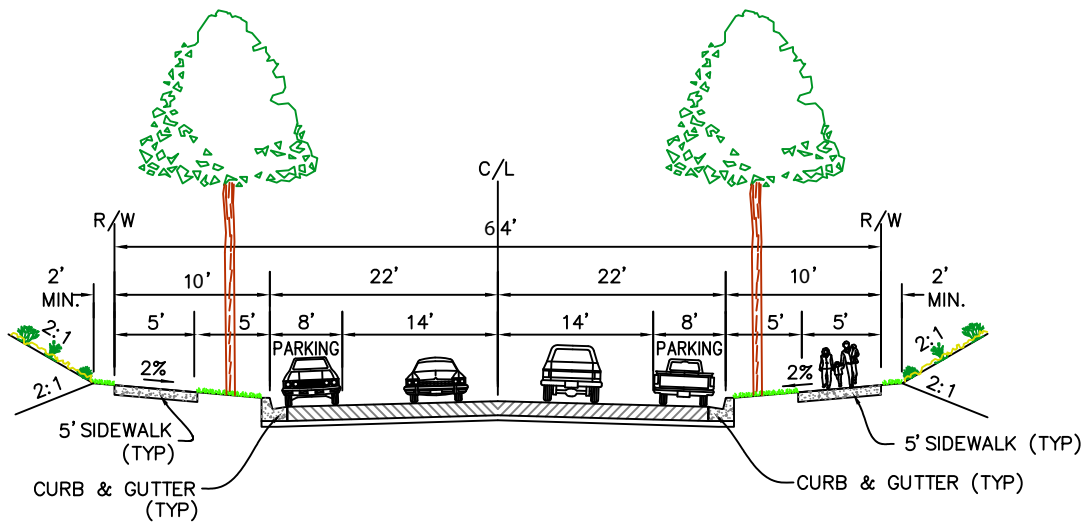

'A', 'B' & 'Q' DRIVES (PVT.)

CROSS SECTION

NOT TO SCALE

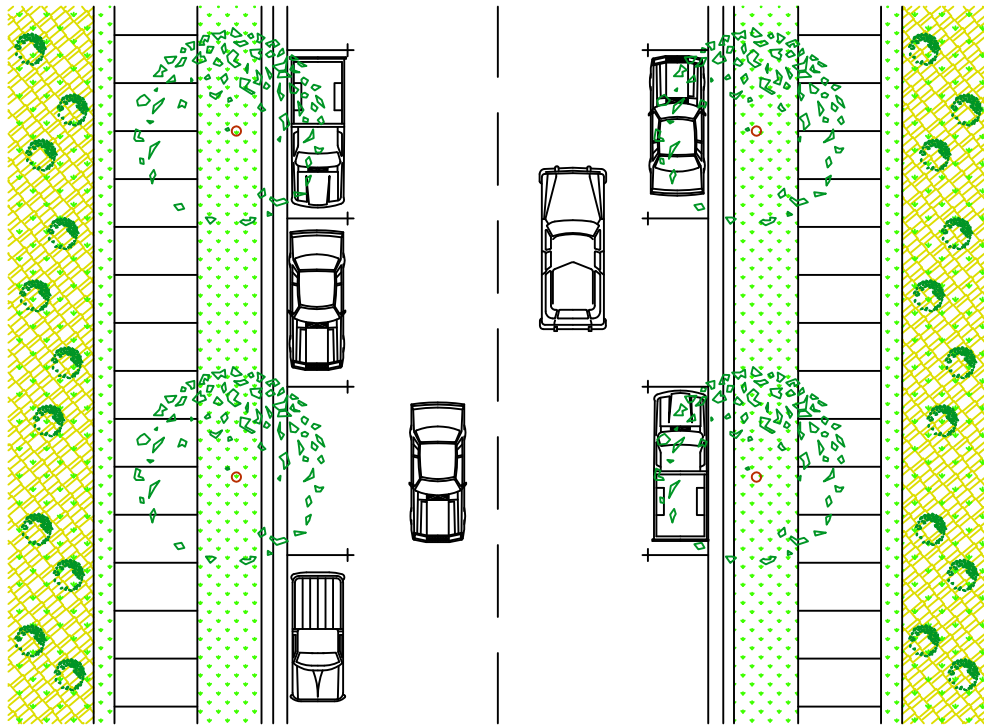

PLAN VIEW

NOT TO SCALE

NOT TO SCALE

FIGURE 2.0-14

Road Sections (A, B & Q Drives)

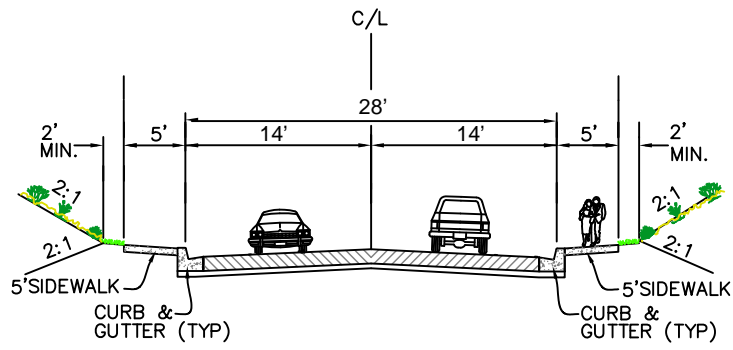

'C', 'D' & 'G' DRIVES (PVT.)

CROSS SECTION

NOT TO SCALE

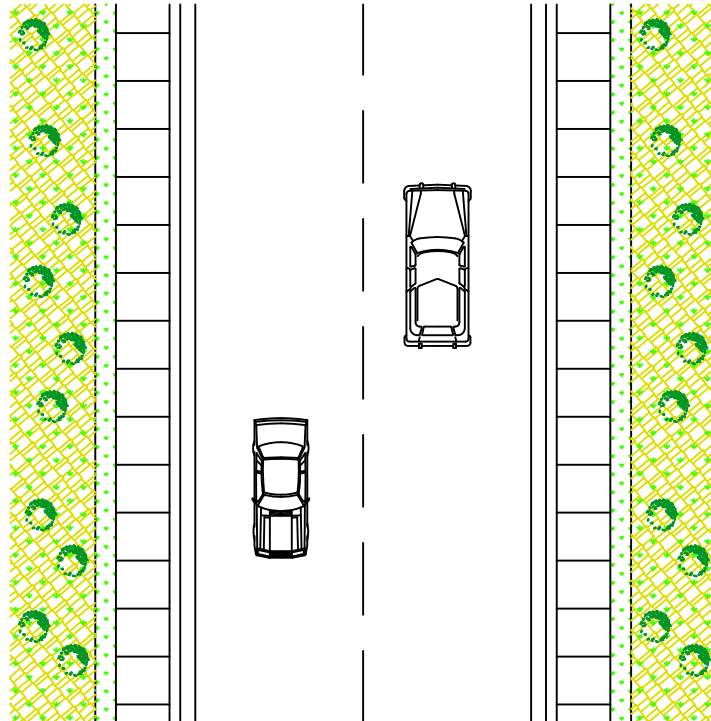

PLAN VIEW

NOT TO SCALE

NOT TO SCALE

Figure 2.0-15

Road Sections (C, D and G Drives)

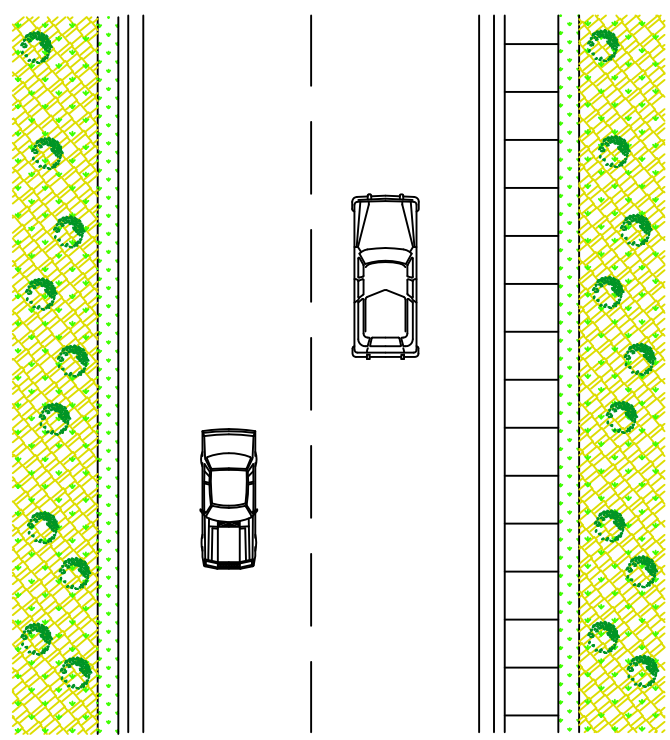
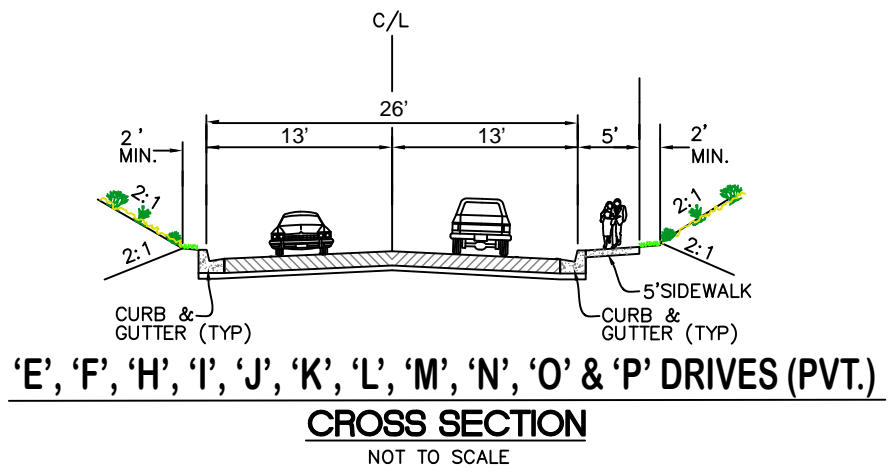

NOT TO SCALE

Figure 2.0-16 Road Sections (E, F, H, I, J, K, L, M, N, O, and P Drives)

2.4.4 PARKING PLAN

The Specific Plan creates a shared and non-shared parking program for PA-1 and PA-2, and promotes a "park once" strategy. Parking requirements are typically based on the peak parking demand predicted for each single land use, each use accompanied by parking lots, with parking spaces dedicated for each visit to each individual use. Ordinances usually require that each site provide enough parking to exceed the maximum demand, not accounting for "park once" users that patronize several different uses within a commercial site, or that utilize different peak demand periods in a mixed-use site, or that present non-automobile options such as transit, walking, and bicycling. Under these traditional parking ordinance requirements, the result is unused parking spaces during times of the day when there is less activity and other negative consequences such as over-parking or devoting excessive land or resources to parking.

By contrast, the Specific Plan's mixed-use design will lend itself to reduced daily trips and less required parking spaces by utilizing "park once" parking strategies in PA-1 and PA-2. The Specific Plan's "Parking Demand Analysis," prepared by Richard Willson, Ph.D., FAICP, dated April 2010, is included in **Appendix 2.0-1**. This parking plan analyzes parking demand and establishes parking requirements for PA-1 and PA-2. To ensure consistency, the Specific Plan requires updates to the program as PA-1 and PA-2 buildout. PA-3 is self-contained and will comply with SCMC parking standards, as amended.

Under the Specific Plan's parking program for PA-1 and PA-2, the proposed residential parking supply is 1,277 spaces, based on the Urban Land Institute (ULI) Shared Parking Recommended Parking Ratios of 1.5 spaces per unit for rental units and 1.7 spaces per unit for ownership units. This parking will be reserved for residents and is not part of the shared parking pool. Guest parking is not included in this total (1,277 spaces), but is included in the shared parking calculations presented below for non-residential uses.

As to non-residential uses and guest parking, the proposed parking supply is 2,939 spaces. This supply was calculated as follows: 2,721 spaces to accommodate peak weekday demand for PA-1 and PA-2, plus an 8 percent parking vacancy factor, which adds 218 parking spaces, resulting in 2,939 spaces.

Combining the proposed non-shared residential parking (1,277 spaces) and the non-residential and guest parking (2,939 spaces) yields a recommended Specific Plan parking supply for PA-1 and PA-2 of a total 4,216 spaces.

The amount of Specific Plan parking shown in PA-1 and PA-2 is 4,390 space; therefore, PA-1 and PA-2 will exceed the parking level recommended in the Specific Plan's parking program by 174 spaces. **Table 2.0-3**, provides a comparison of the SCMC parking space requirements and the parking space requirements recommended by the Specific Plan for PA-1 and PA-2. The ULI model and associated adjustment procedures are included in the Specific Plan, and will replace the SCMC parking requirements for PA-1 and PA-2.

Table 2.0-3 Comparison of Parking Levels			
	SCMC Parking Requirements¹	Vista Canyon Parking Reduction/Shared Parking Demand Analysis	Vista Canyon Parking Supply
Residential Spaces, Excluding Visitor; Not Shared	1,516	1,277	1,277
Visitor Parking (Residential Uses)	410	Part of shared parking pool	Part of shared parking pool
Commercial, Metrolink, and Residential Visitor Spaces; Shared	4,761	2,939 ²	3,073
Total Spaces	6,687	4,216	4,390
<i>Notes:</i> ¹ These calculations are based on project data derived from Tentative Tract Map No. 69164 using parking calculations from the City's Unified Development Code ² The peak weekday parking demand is 2,721 parking spaces, plus an 8% parking vacancy factor (2,721 + 218 = 2,939).			
Source: Parking Demand Analysis, Vista Canyon Transit-Oriented Development (Planning Areas 1 and 2), prepared by Richard W. Willson (April 2010)			

2.4.5 TRANSIT PLAN

The Specific Plan's transit component is intended to create a variety of alternatives to the use of automobiles, and proposes to relocate the Via Princessa Metrolink Station to the property site. This will be accomplished by providing the land and partnering with the City and Metrolink on funding for facilities needed for a multi-modal transit hub, to be located north of the existing Metrolink rail line along the Specific Plan's southern boundary in PA-2. The transit hub will consist of a Metrolink Station and Bus Transfer Station. The existing, successful commuter rail service at the Jan Heidt Metrolink Station, within the transit-oriented Downtown Newhall Specific Plan area, is a strong indicator of the likely success that will follow with the Specific Plan's transit center.

The Metrolink Station component of the transit hub will require construction of a platform and accessory station improvements within the Metrolink right-of-way, as shown on Tentative Tract Map No. 69164. These improvements include construction of approximately 3,500 feet of a second main line, installation of a new turnout and signal, construction of approximately 1,000 linear feet of intertrack fencing, and completion of associated grading. The transit hub will likely be constructed in two phases, with the first phase including construction of the Metrolink

platform, portions of the second main line, and adjacent surface parking. The second phase will include construction of a pedestrian overpass and undercrossing, adjacent parking structure, and Bus Transfer Station.

At buildout, the Specific Plan will construct one four-story, five-level parking structure with 750 parking spaces, which will be utilized by transit users and be part of the shared parking pool for PA-2 during evenings and on weekends. The parking structure also will include restroom facilities and a security/waiting room. Vehicular access to the Metrolink and Bus Transfer Stations will be from Vista Canyon Road and the Specific Plan's "Main Street" (Vista Square). In addition, a pedestrian overpass from the third level of the parking structure to the north platform and a pedestrian underpass to the south platform will be constructed.

The Vista Canyon multi-modal hub will also include the Bus Transfer Station, which will be similar to the station currently operated by the City at McBean Parkway and Valencia Boulevard. The transfer facility will consist of seven bus bays arranged around a loop road with covered passenger shelters.

The transit center conceptual site design is depicted below in **Figure 2.0-17**.

2.4.6 TRAILS PLAN

The Specific Plan's Trails Plan provides for a comprehensive trail system throughout the Specific Plan's three Planning Areas as well as other open space areas, linking these areas to each other and the existing Santa Clara River Regional Trail. In summary, the Specific Plan will include over 4 miles of bicycle, pedestrian, and equestrian trails throughout the Specific Plan site. The primary trails within the Specific Plan include extensions of the Santa Clara River Trail and the Oak Park Trail, which will extend from Oak Park in PA-3 westerly to the town center in PA-2. Another trail, the Loop Trail, will begin at Lost Canyon Road near the existing segment of La Veda Avenue and extend along the Specific Plan's easterly and southerly boundaries terminating in PA-1. The trail system also will include direct connections to the City's existing regional trail system and the Santa Clara River Regional Trail, providing recreation opportunities for local residents and the region. The trails will provide connectivity to the living, shopping, work, entertainment, office, park, and recreation facilities throughout the Specific Plan site. The Specific Plan's trail system will also be accessible to pedestrians, equestrians, hikers, joggers, and bicyclists.

2.4.6.1. Santa Clara River Regional Trail

The Santa Clara River Regional Trail is located on both the north and south sides of the Santa Clara River, and will provide a recreational amenity and open space within the Specific Plan for local residents and residents from surrounding communities. The Specific Plan's extension of this regional trail will represent an important recreational feature of the Specific Plan, allowing

both active and passive enjoyment along the Santa Clara River. The Specific Plan trail design will accommodate combined pedestrian, bicycle, and equestrian uses.

The Specific Plan's extension of the Santa Clara River Regional Trail also will provide a direct connection to Vista Canyon Road, providing access into Vista Square and PA-2. This trail extension will be up to 34 feet wide, located along the Santa Clara River, and provide access for maintenance of bank stabilization, water quality facilities, utilities, and other flood control facilities.

2.4.6.2 Community Trails

The Specific Plan will include numerous pedestrian and bicycle community trails internal to the site, providing trail access to the Santa Clara River Regional Trail, Oak Park Trail, and Loop Trail. These trails are to provide access to the Specific Plan's amenities and serve to link the various land uses within the Specific Plan site.

Figure 2.0-18 illustrates typical trail sections used within the Specific Plan.

2.5 SANTA CLARA RIVER CORRIDOR

2.5.1 RESOURCE DESCRIPTION

The Specific Plan area includes a reach of the Santa Clara River between the terminus of existing Jakes Way to the west and existing La Veda Avenue to the east (see **Figure 2.0-19, Existing Santa Clara River Within Project and Vicinity**). This reach, which is under the jurisdiction of the Corps and CDFG, is dry except after periods of heavy rainfall, generally occurring during the winter months.

The Santa Clara River is a regionally significant biological resource, and its significance is derived from the riparian habitat in the River and its function as a regional east-west wildlife corridor within the Santa Clara River watershed. As part of the Specific Plan, a River Corridor has been delineated, corresponding to the area designated SP-OS. The River Corridor is designed to be sufficiently wide to handle flooding while retaining and enhancing the majority of the riparian habitat that exists on the property site. In areas where riparian habitat must be disturbed, the Specific Plan requires such areas to be mitigated through restoration and enhancement activities, as discussed below.

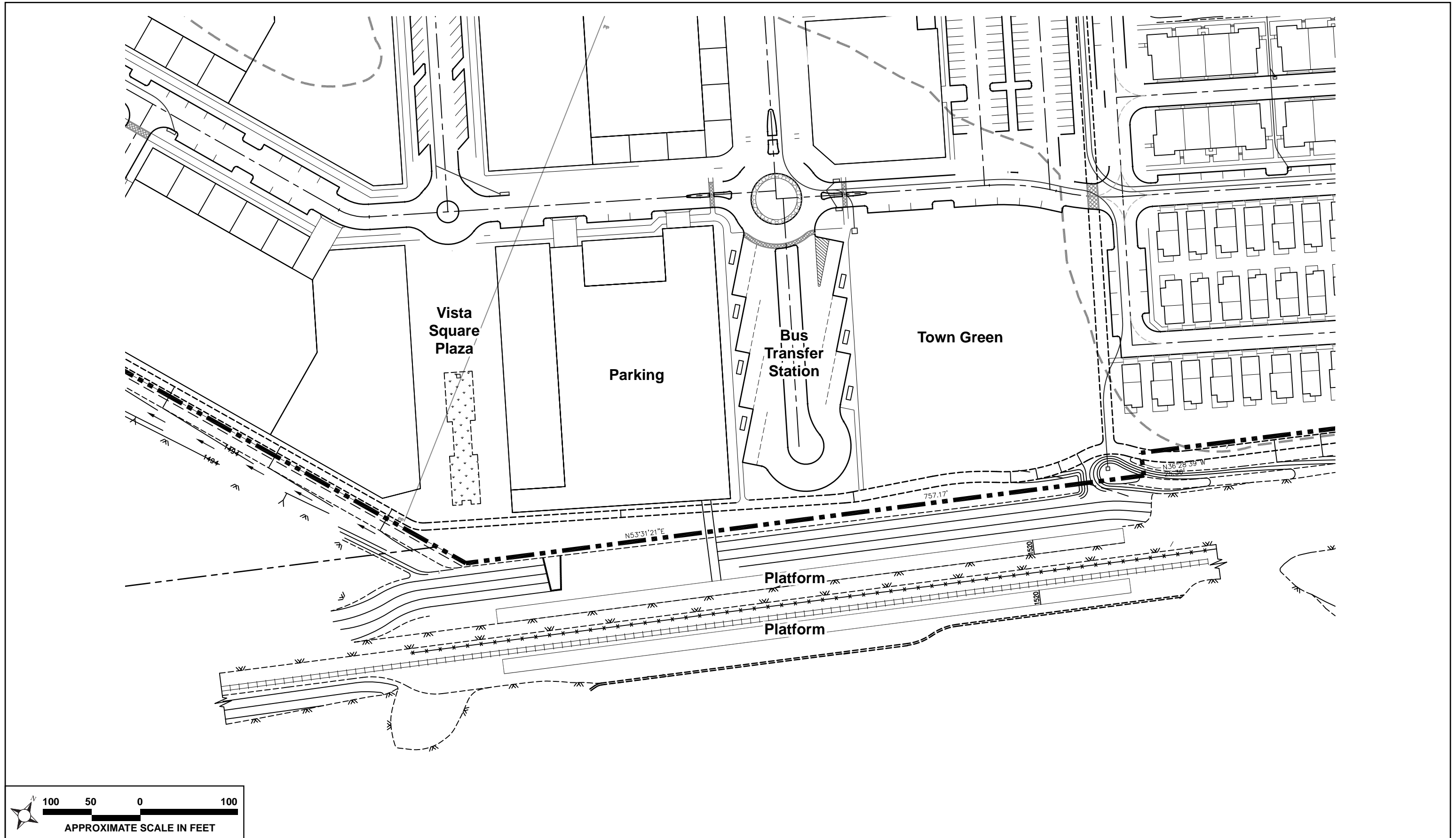
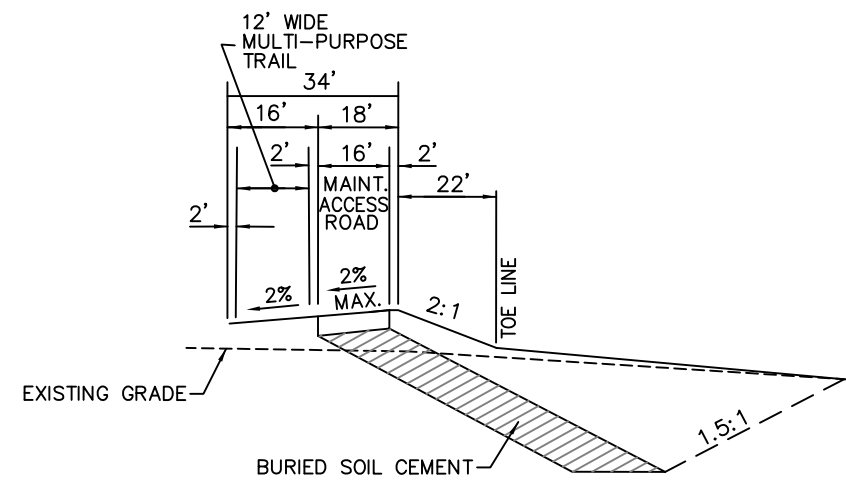
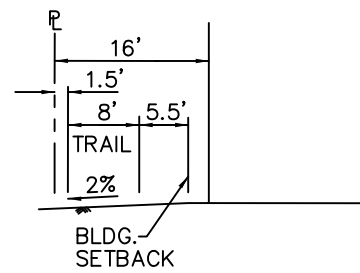

Figure 2.0-17



SECTION A-A *
TYPICAL SECTION-BANK STABILIZATION
 NOT TO SCALE



SECTION B-B *
 NOT TO SCALE

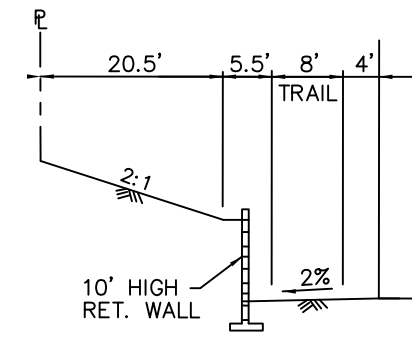

SECTION C-C *
 NOT TO SCALE

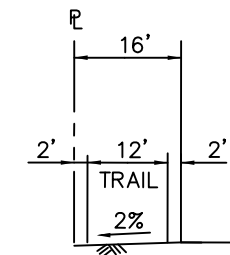

SECTION D-D *
 NOT TO SCALE

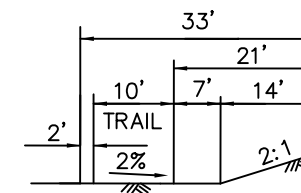

SECTION E-E *
 NOT TO SCALE

NOT TO SCALE

* SEE THE VTTM FOR
 ACTUAL CROSS-SECTION LOCATION

Figure 2.0-18

Typical Trail Sections (cross sections of various trail types)

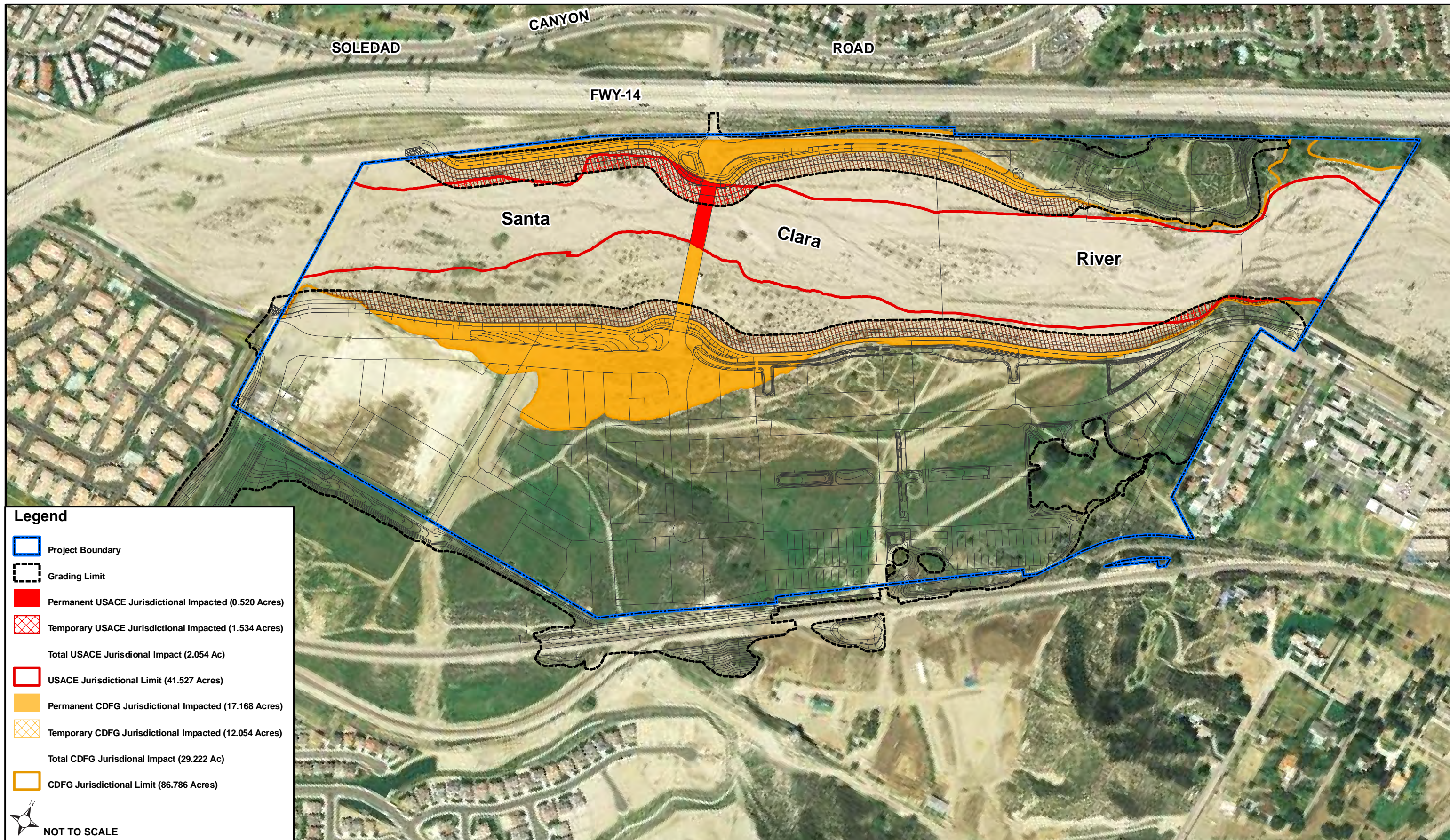

Figure 2.0-19

Existing Santa Clara River Within Project and Vicinity

The Santa Clara River also is part of SEA 23. The SEA designation is one of several land use designations set forth in the City and County General Plans, and generally identifies lands having important biological resources. The intent of the City and County General Plans is to preserve and enhance SEAs, to the extent possible. However, both the City and County recognize that measures necessary to preserve and enhance biological resources within an SEA vary, depending upon the nature of resource values present and the likelihood of potentially incompatible development. Development is not prohibited within SEAs; however, it should be designed to minimize impacts to sensitive biological resources to assure the ongoing viability of the SEA.

The Specific Plan proposes a General Plan Amendment and a Specific Plan designation that would change the SEA boundary to be consistent with identified sensitive biological resources. Additionally, the Specific Plan will require mitigation of project impacts within the River Corridor through restoration and enhancement; provide for transition areas between the River Corridor and development; restrict uses; and include long-term management, monitoring, and maintenance of the River Corridor.

For further information, please refer to the Vista Canyon EIR, **Section 4.20, Santa Clara River Corridor Analysis**.

2.5.2 MITIGATION REQUIREMENTS

Mitigation for impacts of the Specific Plan on jurisdictional waters and riparian habitat will include restoration and enhancement activities. **Figure 2.0-20, Location of Mitigation Areas**, depicts the areas in which the mitigation activities will take place within the River Corridor.

2.5.2.1. Mitigation Through Restoration/Enhancement

Based on the Specific Plan's biological assessment (Forde, *et al.* 2008), the Specific Plan site supports a variety of on-site vegetation communities. The jurisdictional riparian habitat that will be impacted by the Specific Plan include riparian scrub and alluvial scrub. On-site vegetation communities have been subject to repeated disturbance from utility construction and maintenance, illegal dumping, unauthorized off-road vehicle activity, flood management activities, and natural fluvial processes characteristic of the Santa Clara River. Consequently, vegetation communities throughout the majority of the Specific Plan are either disturbed or in an early successional state.

The River Corridor is composed of multiple braided channels and alluvial deposits consisting of a relatively low cover of herbaceous annual vegetation with occasional, sparsely spaced emergent shrubs and trees. The floodplain terraces also are composed of relatively sparse vegetation, but include significant stands of alluvial scrub species such as scalebroom (*Lepidospartum squamatum*), California buckwheat (*Eriogonum fasciculatum*), Deerweed (*Lotus scoparius*), and whipple yucca (*Yucca whipplei*).

Due to substantial site disturbance, the functions and values for wildlife are somewhat diminished. However, these vegetation communities still provide nesting, foraging, and breeding opportunities for various aquatic, terrestrial, and avian animals.

The jurisdictional areas also provide functions and values typical of channel and floodplain environments, including energy dissipation during stormflow events, nutrient cycling, uptake of elements and compounds, entrapment of sediments, and hydrologic variation in flow patterns.

The riparian habitat within the Santa Clara River that is impacted by the Specific Plan will require mitigation through restoration and enhancement activities; however, minimization of impacts to such resources was the primary goal during design of the Specific Plan. In order to assess the functionality of the River Corridor within the Specific Plan site, Dudek & Associates, Inc. prepared a report, entitled *Vista Canyon California Rapid Assessment Methodology Report* (CRAM report; 2008). The purpose of this assessment was to determine the condition and function of the wetlands within the River Corridor area of the Specific Plan site. The CRAM report was used to plan and design the Specific Plan land uses and the habitat restoration and enhancement mitigation activities within the River Corridor. In addition, impacts to riparian habitat within the Santa Clara River will be mitigated through implementation of the Specific Plan's *Conceptual Wetland Mitigation and Monitoring Plan*, prepared by Dudek & Associates, Inc., (2009). Both this plan and the CRAM report are included as appendices to the Vista Canyon EIR.

The Specific Plan also will require subsequent federal and state permitting from responsible agencies, including the CDFG streambed alteration agreement required by Fish and Game Code section 1600, *et seq.*, and the Corps' section 404 permit, as well as a section 401 certification/consultation with the Regional Water Quality Control Board (RWQCB). The mitigation and monitoring activities will include the following parameters:

Establishment of Riparian Habitat. The riparian vegetation communities proposed to be established in the River Corridor are alluvial scrub and riparian scrub in temporary impact areas within the channel, and Great Basin sage scrub on the channel banks. The character and species composition of the restored/enhanced vegetation communities is intended to be consistent with the character and species composition of the existing alluvial scrub and riparian scrub.

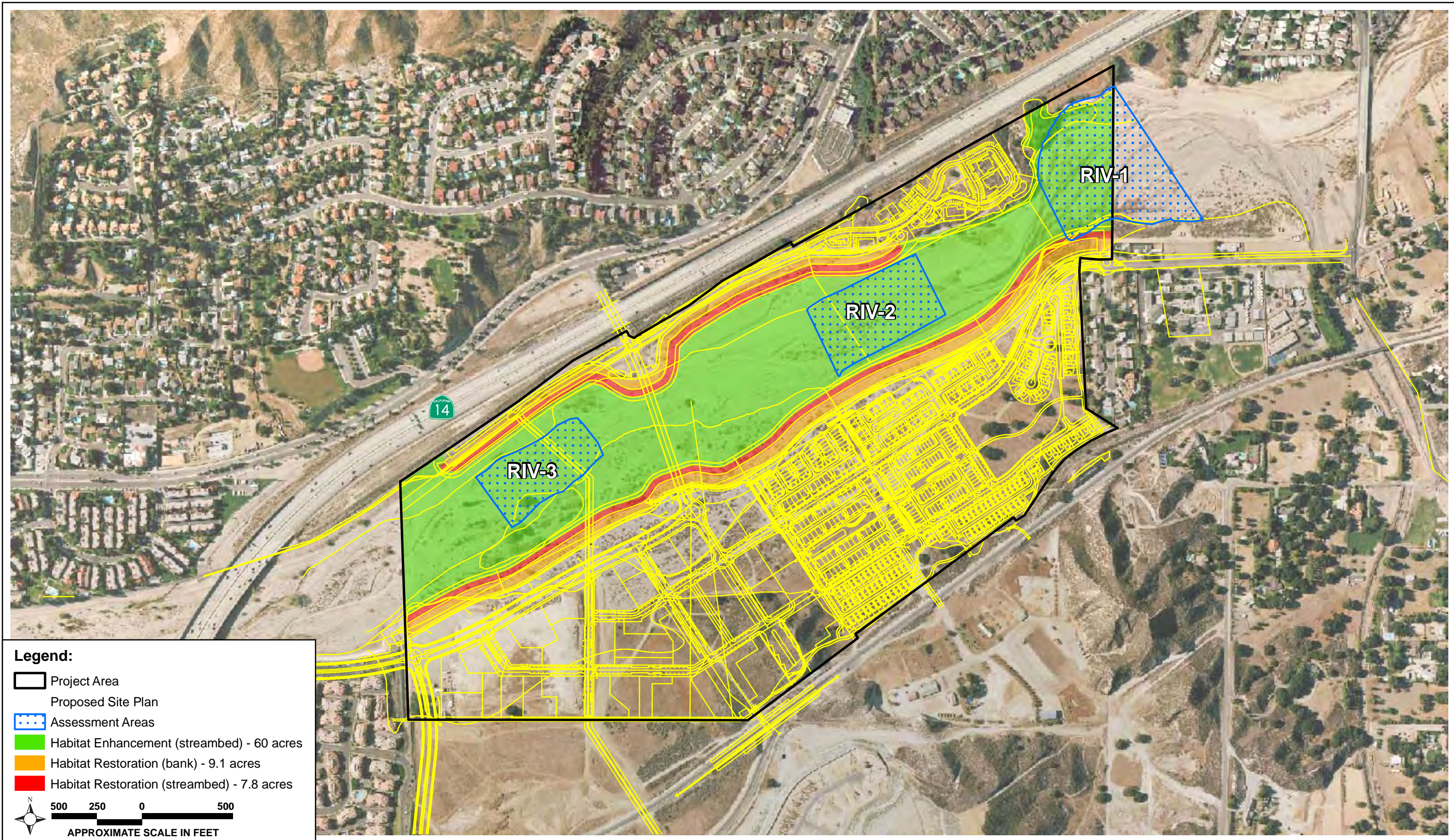

Figure 2.0-20

Location of Mitigation Areas

Long-Term Monitoring. To ensure that the restoration and enhancement areas in the River Corridor meet success criteria to be established by the permitting agencies, a five-year monitoring period will be implemented. During this time, the River Corridor site will be monitored by a Habitat Restoration Specialist, who will then make recommendations to a Restoration Contractor to perform maintenance tasks necessary to keep the River Corridor site in compliance with success criteria. Should the River Corridor not meet the final sign-off criteria by the end of year five, the monitoring period will be extended until final sign-off is obtained, which shall not be unreasonably withheld.

Recommended Plant Palette for Mitigation Areas. The restoration areas will be planted with seed and container plants. Enhancement areas generally will not be planted, but instead will rely on natural recruitment. Some limited planting in enhancement areas may occur in places where large areas are disturbed from the removal of revetment structures or non-native invasive species.

As noted above, riparian scrub and alluvial scrub are planned for designated areas within the River Corridor. The primary difference between the two communities is that plant cover is much lower in riparian scrub than in alluvial scrub, due to the repeated scouring from infrequent high-velocity channel flows. Great Basin sage scrub occurs in areas that are transitional from riparian and alluvial scrub to upland vegetation. Therefore, the Great Basin sage scrub is for designated areas on the banks. Planting palettes for the three on-site restoration/enhancement mitigation areas are shown in **Tables 2.0-4** through **2.0-6**.

**Table 2.0-4
Riparian Scrub Plant Palette**

Seed Mix	
Common Name	Botanical (Scientific) Name
Mugwort	<i>Artemisia douglasiana</i>
Tarragon	<i>Artemisia dracunculus</i>
California sun cup	<i>Camissonia bistorta</i>
western marsh cudweed	<i>Gnaphalium palustre</i>
Scalebroom	<i>Lepidospartum squamatum</i>
Container Plants	
Common Name	Botanical (Scientific) Name
big sagebrush	<i>Artemisia tridentata</i> var. <i>tridentata</i>
mule fat	<i>Baccharis salicifolia</i>
rubber rabbit brush	<i>Chrysothamnus nauseosus</i>
perennial eriastrum	<i>Eriastrum densifolium</i>
California buckwheat	<i>Eriogonum fasciculatum</i> var. <i>foliolosum</i>
creeping wild rye	<i>Leymus triticoides</i>
Thurber's sandpaper plant	<i>Petalonyx thurberi</i>
Fremont cottonwood	<i>Populus fremontii</i>
red willow	<i>Salix laevigata</i>
Source: Dudek (2009)	

**Table 2.0-5
Alluvial Scrub Plant Palette**

Seed Mix	
Common Name	Botanical (Scientific) Name
Mugwort	<i>Artemisia douglasiana</i>
Tarragon	<i>Artemisia dracunculus</i>
big sagebrush	<i>Artemisia tridentata</i>
California sun cup	<i>Camissonia bistorta</i>
thickleaf yerba santa	<i>Eriodictyon crassifolium</i>
western marsh cudweed	<i>Gnaphalium palustre</i>
Scalebroom	<i>Lepidospartum squamatum</i>
branching phacelia	<i>Phacelia ramossisima</i>
Container Plants	
Common Name	Botanical (Scientific) Name
big sagebrush	<i>Artemisia tridentata</i> var. <i>tridentata</i>
four-wing saltbush	<i>Atriplex canescens</i> ssp. <i>Canescens</i>
big saltbush	<i>Atriplex lentiformis</i>
mule fat	<i>Baccharis salicifolia</i>
rubber rabbit brush	<i>Chrysothamnus nauseosus</i>
perennial eriastrum	<i>Eriastrum densifolium</i>
California buckwheat	<i>Eriogonum fasciculatum</i> var. <i>foliolosum</i>
creeping wild rye	<i>Leymus triticoides</i>
Thurber's sandpaper plant	<i>Petalonyx thurberi</i>
western sycamore	<i>Platanus racemosa</i>
Fremont cottonwood	<i>Populus fremontii</i>
red willow	<i>Salix laevigata</i>
Mexican elderberry	<i>Sambucus Mexicana</i>
our Lord's candle	<i>Yucca whipplei</i>
Source: Dudek (2009)	

**Table 2.0-6
Great Basin Sage Scrub Plant Palette**

Seed Mix	
Common Name	Botanical (Scientific) Name
common fiddleneck	<i>Amsinckia menziessii</i> var. <i>intermedia</i>
California brickel bush	<i>Brickellia californica</i>
California sun cup	<i>Camissonia bistorta</i>
rubber rabbit brush	<i>Chrysothamnus nauseosus</i>
perennial eriastrum	<i>Eriastrum densifolium</i>
thickleaf yerba santa	<i>Eriodictyon crassifolium</i>
western marsh cudweed	<i>Gnaphalium palustre</i>
Scalebroom	<i>Lepidospartum squamatum</i>
California aster	<i>Lessingia filaginifolia</i> var. <i>filaginifolia</i>
Deerweed	<i>Lotus scoparius</i>
branching phacelia	<i>Phacelia ramosissima</i>
white sage	<i>Salvia apiana</i>
black sage	<i>Salvia mellifera</i>
Container Plants	
Common Name	Botanical (Scientific) Name
California sagebrush	<i>Artemisia californica</i>
big sagebrush	<i>Artemisia tridentata</i>
four-wing saltbush	<i>Atriplex canescens</i> ssp. <i>Canescens</i>
hoary-leaved ceanothus	<i>Ceanothus crassifolius</i>
California buckwheat	<i>Eriogonum fasciculatum</i>
giant wild rye	<i>Leymus condensatus</i>
coast live oak	<i>Quercus agrifolia</i>
Mexican elderberry	<i>Sambucus Mexicana</i>
our Lord's candle	<i>Yucca whipplei</i>
Source: Dudek (2009)	

Mitigation Implementation. The *Wetland Plan* (Dudek, 2009) contains the mitigation implementation plan and schedule. In summary, no public access will be provided to the mitigation areas, which will be fenced and posted with appropriate signage. Restoration areas will require re-contouring of temporary impact areas following installation of buried bank protection. After completion of bank protection installation, stockpiled native topsoil will be used on the surface of the temporary impact areas and channel banks. **Figure 2.0-21**, below, provides a typical channel cross-section.



Example Photos of Existing Site Conditions (2/4/09)

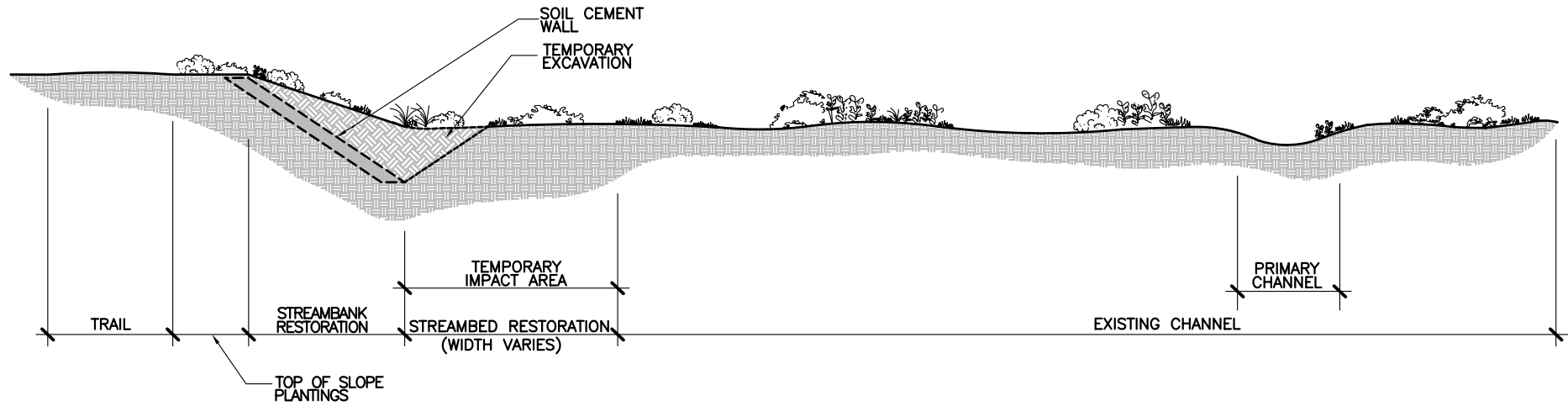

NOT TO SCALE

Figure 2.0-21

Typical Channel Cross-Section

The primary goal of restoration and enhancement mitigation efforts is to establish native vegetation communities capable of maintaining and supporting themselves in perpetuity. A temporary, on-grade irrigation system will be installed to enhance overall success of the restoration and enhancement efforts.

Maintenance Activities During Monitoring Period. The *Wetland Plan* (Dudek, 2009) describes the maintenance activities required in the mitigation areas during the specified monitoring period. In summary, the maintenance activities include weed control, trash removal, and irrigation maintenance.

Monitoring Plan. The *Wetland Plan* (Dudek, 2009) includes the monitoring plan for the mitigation areas in the River Corridor. In summary, the monitoring plan includes a 120-day plant establishment period within a five-year long-term monitoring phase. The monitoring will be based on specified performance standards and success criteria. Monitoring will be both qualitative and quantitative, and follow a specified schedule.

Reporting/Costs. The *Wetland Plan* (Dudek, 2009) sets forth the annual reporting and agency notification requirements for the River Corridor. The Specific Plan applicant or designee will be financially responsible for all costs associated with the implementation, maintenance, and monitoring of the mitigation areas within the River Corridor.

Contingency Measures/Adaptive Management. The *Wetland Plan* (Dudek, 2009) includes contingency measure provisions to be implemented to bring the mitigation areas within the River Corridor into compliance with performance standards and success criteria, if such criteria is not met by the end of the five-year long-term monitoring period. In addition, adaptive management must be implemented in the event of unforeseen or unpredictable circumstances.

2.5.2.2 Management Plan

Upon final approval of the Specific Plan, the River Corridor will be designated public open space and zoned SP-OS. The development standards and allowed uses for the River Corridor are governed by the Development Regulations set forth in **Section 4.0** of the Specific Plan.

Upon completion of all land uses, utilities, road, flood control improvements, bridges, trails, and other improvements necessary to implement the Specific Plan within the River Corridor, the Specific Plan applicant or designee must dedicate the portion of the River Corridor under its ownership to the City.

Although there will be no public access to, or use of, the mitigation areas, the Los Angeles County Department of Public Works may require flood control maintenance access in some areas along the bank protection to inspect and maintain the public drainages/outlets. However, the limits of the mitigation areas within the River Corridor will be established outside of the flood control maintenance access areas. The new bridge across the Santa Clara River also will

have adequate barriers at the bridge perimeters to discourage access to the mitigation areas within the River Corridor.

2.6. SUSTAINABILITY PLAN

2.6.1 INTRODUCTION

The Specific Plan includes project design features to reduce GHG emissions associated with site development and promote sustainability. The applicant, in cooperation with the City, identified numerous sustainability strategies, which are included in the Vista Canyon Sustainability Plan (May 2010), which is found in **Appendix 2.0-2** of the Specific Plan.

Because motor vehicle usage accounts for roughly half of the Specific Plan's estimated GHG emissions inventory, Project-related traffic reduction measures incorporated into the design of the Specific Plan include the creation of a mixed-use community that situates jobs and services in close proximity to residences, provides public transit options, and provides trails, bicycle lanes, and sidewalks to encourage non-vehicular options. Significant reductions in mobile source emissions also are likely to result from the future implementation of various federal and state programs designed to improve vehicular engine and fuel efficiency.

The remaining major source of GHG emissions within the Specific Plan is associated with the energy use in residential and non-residential land uses. The project applicant will require that Title 24 (2008) energy requirements be exceeded by 20 percent for residential and non-residential structures within the Specific Plan site. Building design options could involve using energy efficient window glazing, wall insulation and ventilation systems, which reduce energy demand and GHG emissions. Other strategies include the installation of ENERGY STAR appliances and an 80,000-square-foot photovoltaic system (or equivalent).

2.6.2 APPLICATION OF PROJECT DESIGN FEATURES TO VISTA CANYON

Foremost among the design features that will reduce GHG emissions and promote sustainability is the Specific Plan's provision of property and funding for the new multi-modal transit hub to facilitate transit, reduce automobile trips, and direct pedestrian access to and from such facilities through trails and sidewalks that connect to the Specific Plan's residential, retail/commercial, and office areas. In addition, the Specific Plan creates a one of a kind opportunity for new employment in the eastern Santa Clarita Valley with premier office, retail, and live/work uses integrated within a street system oriented around a "Main Street" (Vista Square). A diversity of housing types also is provided, in conjunction with a proposed trail system and public and private parks connecting to the town center design and the new City/Metrolink transit center.

As shown, the Specific Plan will incorporate various components of a sustainable community, including the following:

- (a) **Mix of Land Uses.** Vista Canyon will include a broad range of housing types, along with retail/commercial/office and associated facilities. The residential component includes a diverse range of 1,100 residential units. To minimize and shorten vehicular trips, all residential units will be within walking distance (0.5 mile or less – the majority of residential units are 0.25 mile or less) to the Specific Plan's mixed-use, retail/commercial, and office uses. The Specific Plan also will create opportunities for non-vehicular travel and encourage pedestrian mobility by providing an internal trail/sidewalk circulation system that links residential neighborhoods to nearby schools, area parks, and adjacent park and recreation areas.
- (b) **Provision of Jobs.** A portion of the Specific Plan's 2,000 to 4,000 new jobs will be offered in its retail/commercial and office areas. When combined with other job centers in the Santa Clarita Valley, the Specific Plan will improve the Santa Clarita Valley's jobs-housing base, which is critical to a sustainable community because it allows people to work close to home and minimize vehicle trips and vehicle miles traveled.
- (c) **Locating Residential in Close Proximity to Commercial/Retail/Public Spaces.** All of the residential units in the Specific Plan will be located within walking distance of retail/commercial and office areas. Residents within Vista Canyon will be able to utilize trails, sidewalks, and the Santa Clara River Regional Trail to walk to retail/commercial centers, offices, public and private recreation facilities, parks, and nearby schools. As stated above, this traditional neighborhood approach, designed around a mix of other land uses, will minimize vehicle trips and vehicle miles traveled.
- (d) **Transit-Oriented Development.** The Specific Plan site is uniquely situated in proximity to Metrolink rail lines, and affords the opportunity to plan a new City/Metrolink transit center to facilitate transit, reduce automobile trips, and create a lively place to live, work, play, and shop.
- (e) **Open Space, Recreation, and Parks.** The Specific Plan includes extensive open space, recreation opportunities, and public/private parks to serve the neighborhoods within Vista Canyon. These areas are linked by the Specific Plan's trail system, which promotes walking and biking while minimizing vehicle trips.
- (f) **Reducing Impermeable Surfaces.** To curtail urban runoff and maximize groundwater recharge, the Specific Plan will utilize smaller street sections where possible, native landscape areas, permeable pavement in various parking areas, and non-structural water quality treatments. This design reduces impermeable surfaces and minimizes urban "heat island" effects. Not including permeable pavement areas or landscape areas within each lot, the Specific Plan will utilize permeable payment areas in on-street parking areas within PA-1 and PA-2.

- (g) **Water Conservation and Reuse.** The Specific Plan includes construction of a water reclamation plant (WRP) that will provide for the Specific Plan's irrigation needs, and also provide additional recycled water for off-site uses. The proposed Vista Canyon WRP will generate enough recycled water to completely offset the Specific Plan's total water demand based on product type-specific water demand estimates generated for the Specific Plan. Additionally, the Specific Plan includes provisions that require several water efficiency strategies, including minimization of turf, use of drought-tolerant landscaping, automated irrigation systems, and water-efficient appliances and fixtures.
- (h) **Traffic/Transportation Improvements.** The Specific Plan's traffic circulation plan minimizes vehicle trips and reduces GHG emissions through the design of internal roads in conjunction with homes, nearby schools, retail/commercial areas, offices, and trail systems. Transit also is uniquely incorporated into the traditional neighborhood and town center design. Trails and bike paths leading to close-to-home jobs, neighborhood-serving retail, offices, and nearby schools encourage residents to reduce vehicle miles traveled.
- (i) **Energy Efficiency.** First, all residential units and non-residential buildings on the Specific Plan site will exceed the 2008 Title 24 building energy efficiency standards by at least 20 percent; that is, the units and buildings will be more energy efficient than state law requires. Second, the project applicant or designee will provide Energy Star appliances and equipment for any standard items that are included in the residential and non-residential structures within the Specific Plan site. These will include Energy Star clothes washers, dishwashers, and refrigerators. For office buildings, Energy Star office equipment (such as monitors, printers, copiers, *etc.*) will be mandated. Third, the project applicant or designee will coordinate with the City of Santa Clarita, Southern California Edison and Southern California Gas Company to secure installation of energy efficient municipal lighting and smart meters at the residential units.
- (j) **Renewable Energy.** An 80,000-square-foot photovoltaic system (or equivalent) will be constructed on the project site to help offset the Specific Plan's reliance on electricity and natural gas. Additionally, solar heating will be used for all on-site community pools.
- (k) **Solar Energy System Option.** Consistent with Governor Schwarzenegger's Million Solar Roofs Plan, the project applicant or designee, acting as the seller of the single-family residences constructed as part of the development, will offer a solar energy system option to all customers that enter into negotiations to purchase a new home; this offer will include the total installed cost of the solar energy system option and the customer's estimated cost savings.

2.7 LANDSCAPE PLAN

The Vista Canyon Conceptual Landscape Plan is shown on **Figure 2.0-22**. The conceptual landscape plan for Vista Canyon focuses primarily on the use of native and drought tolerant tree and plant species to create a natural and vibrant environment. All plant species listed, both native and non-native, have been chosen due to their ability to thrive in the Santa Clarita climate and their potential to add complexity and texture to the open space/landscape areas within the Specific Plan. Plants listed that are non-native or not drought tolerant will be used sparingly and only in areas that require their unique properties such as bio-swales, rain gardens, northern building exposures, and commercial high use areas. The use of turf will be limited and only used in locations where it will serve for passive or active recreation. Minimum turf will be used in road medians or along major streets.

The irrigation systems will be designed, installed, operated, and maintained in conformance with the State Water Efficient Landscape Ordinance. The main objective for the irrigation design is to minimize water use, maximize efficiency, and explore the feasible uses of recycled water. These objectives will be met through the use of Smart ET Based controllers, hydro-zoning, moisture sensors, rain-shut-off devices, cisterns, and drip irrigation. Although much of the native planting areas may receive temporary irrigation, a permanent irrigation system is important for a majority of the landscape planting in order to comply with the Los Angeles County Fire Department Fuel Modification Guidelines.

There are two major varieties of oaks that will be planted as mitigation oak trees: the evergreen Coast Live Oak (*Quercus agrifolia*) and the deciduous Valley Oak (*Quercus lobata*). Open space has been established for the planting of oak trees. The largest of the areas is a 2-acre portion of the proposed Oak Park. This area will provide abundant open space for up to 100 mitigation oak trees. The Town Green and Mitchell Hill Open Space areas also will include the planting of oak trees. Finally, the open space along the river trails, the project trails, and the Santa Clarita River revegetation zone also will create opportunities for mitigation oak tree planting.

2.8 PARKS AND RECREATION PLAN

The Specific Plan's parks and recreation component provides exceptional active and passive recreational opportunities for its residents. **Figure 2.0-23, Parks and Recreation Plan**, illustrates the locations of public and private parks and recreation facilities in relation to other designated open space within the Specific Plan. As discussed in further detail below, the primary Specific Plan recreational amenities include the approximately 10.8-acre Oak Park/River Education Center, 1-acre Town Green, and Community Garden. Up to six private recreational facilities also will be provided in the Specific Plan. **Figures 2.0-24, 2.0-25, and 2.0-26**, below, illustrate the conceptual park concept designs.

The Vista Canyon Parks and Recreation Plan includes the following active and passive park that will be accessible to the general public:

The proposed 10.8-acre Oak Park will be located in the southeast portion of the Specific Plan, in PA-3. The park will include the River Education Center, as well as an approximately 2-acre oak tree preserve and mitigation area for passive uses. The remaining acreage will be developed with improvements similar to a neighborhood park, with easterly portions utilized for an animal movement corridor. The park will be dedicated to the City.

The Vista Canyon Parks and Recreation Plan also includes the following private parks:

The site will include the following private recreation facilities, totaling approximately four (4) acres: The Community Recreation Area will be located within PA-3 and consist of a pool and restroom facilities. Multi-family recreation areas and courtyards also will be located adjacent to multi-family uses on the western portion of the Specific Plan, in PA-1 and PA-2.

The 0.3-acre Community Garden will be centrally located within PA-2. The garden and amenities will be available for residents, and owned and maintained by a homeowners' association.

The 1-acre Town Green will be developed with a picnic area, sitting area, and other public recreation/entertainment facilities. Areas of the Town Green along the Santa Clara River Trail will be planted with native and/or drought tolerant vegetation. The area also will be accessible to the public, though it would be owned and maintained by a property owners association.

2.9 PHASING PLAN

The Specific Plan will be completed in multiple phases in order to correlate infrastructure and amenities with site development. The sequence of development will be influenced by the following factors: (a) market conditions and changes; (b) economic conditions and changes; (c) rate of growth in the immediate vicinity and region; and (d) changes in infrastructure/public facilities requirements, conditions, and needs. As these factors change during buildout of the Specific Plan, adjustments in corresponding infrastructure requirements may be needed. However, it is anticipated that there will be four phases of development with the initial phase being occupied in 2012 and the last phase being completed in 2015. Each phase will have specific infrastructure and amenity requirements to ensure that the project is adequately served and City standards are met. The Vista Canyon phasing plan is set forth in **Section 6.0, Specific Plan Implementation**.



Figure 2.0-22



Figure 2.0-23



N
NOT TO SCALE

Figure 2.0-24

Conceptual Park Concepts Designs (Oak Park)

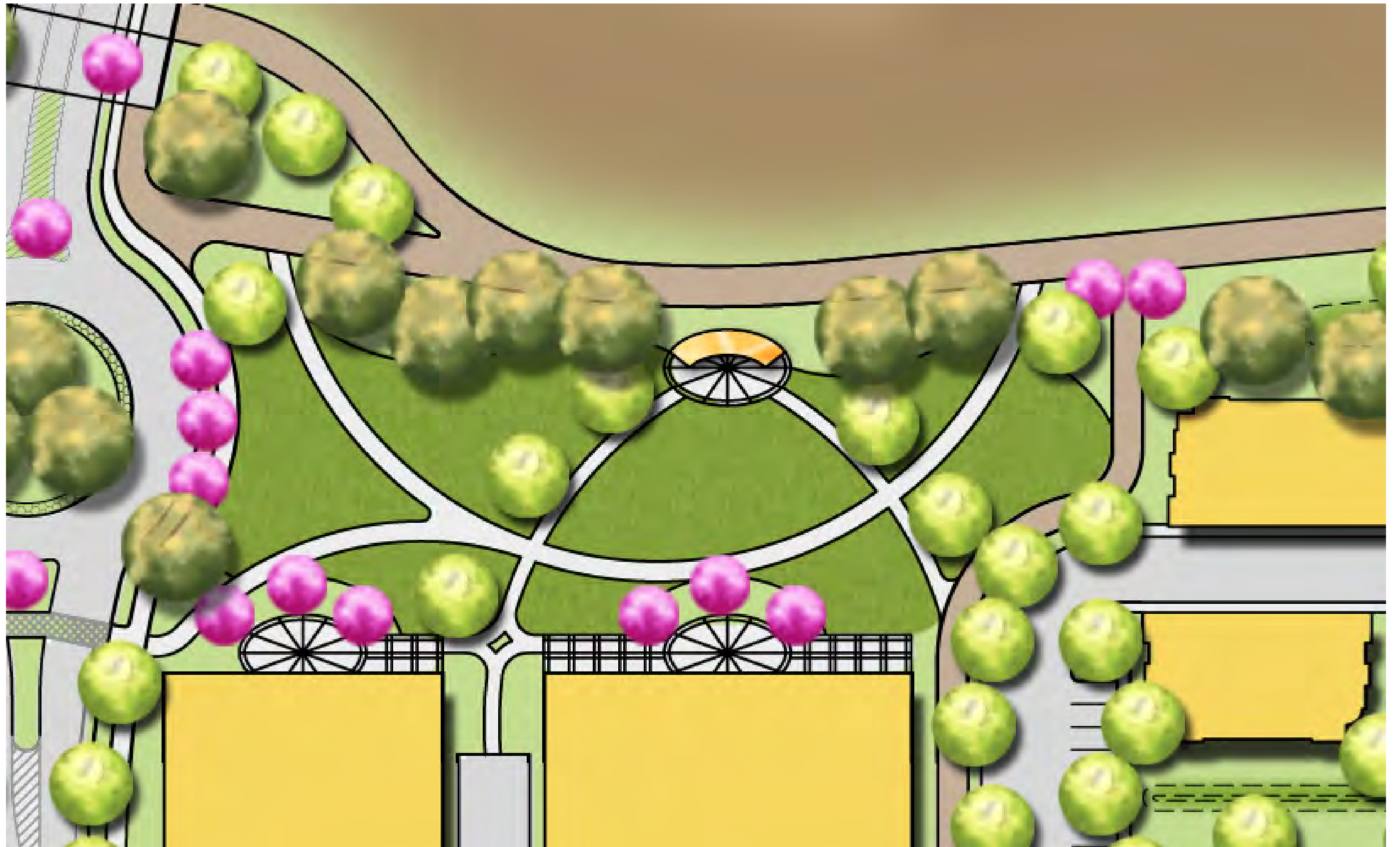

 NOT TO SCALE

Figure 2.0-25

Conceptual Park Concept Design (Town Green)

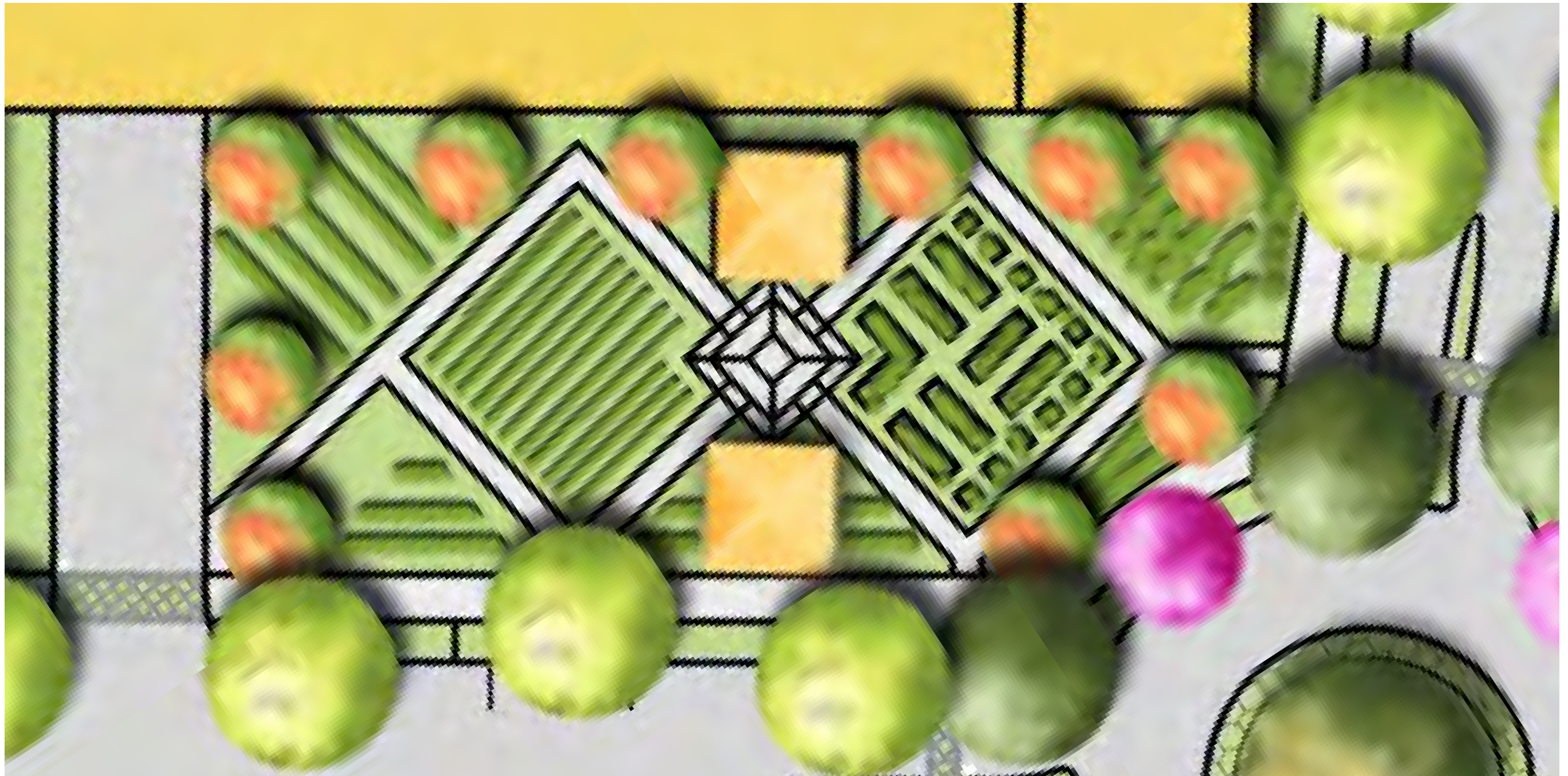

 NOT TO SCALE

Figure 2.0-26

3.0 INFRASTRUCTURE DEVELOPMENT PLAN

3.1 INTRODUCTION

This section addresses the Specific Plan's infrastructure development plans for grading; drainage, water quality, and bank stabilization; water service/recycled water; wastewater service; dry utilities; roadway design; and parking. The section also discusses the Transportation Demand Management program of the Specific Plan. The EIR accompanying the Specific Plan also addresses this infrastructure and includes additional requirements to help ensure that the infrastructure can support the community envisioned by the Specific Plan.

The plans presented in this section are preliminary and are subject to change as detailed engineering designs are prepared, reviewed, and approved by the City as part of the final construction or grading plans. With that said, the plans presented in this section do describe the extent of the proposed infrastructure and associated improvements, and the designs intended to establish the standards by which the final infrastructure/improvement plans must conform.

3.2 GRADING PLAN

3.2.1 EXISTING CONDITIONS

The approximately 185-acre Specific Plan site is shaped irregularly and the topography is relatively flat. The Specific Plan site includes the sandy bottom of the ephemeral Santa Clara River, a small elevated terrace on the northeastern portion of the site, and a larger elevated terrace that forms the southern half of the site. These terraces drain towards the Santa Clara River. Elevations on the Specific Plan site range from a high of 1,555 feet above sea level at the northeastern portion of the site, to a low of 1,465 feet above sea level in the middle of the Santa Clara River. The Specific Plan site is comprised primarily of undeveloped land with the exception of a residential compound/equipment storage yard present on the western side of the site and the Mitchell family cemetery located on the small elevated terrace at the northeastern portion of the site. Remnants of the Mitchell family homestead also are located on the southern portion of the site, and consist primarily of building foundations and fencing associated with past ranching operations.

Conditions on the Specific Plan site have been altered substantially by historic uses of the property, including agricultural cultivation, grading, residential uses and utility installation and maintenance. A substantial amount of illicit dumping has occurred as well. There is little remaining natural vegetation, with the exception of a vegetated area on the southeastern portion of the site that includes some standing oaks and introduced grasses.

3.2.2 PROPOSED CONDITIONS

Within the Specific Plan boundary, the earthwork will consist of approximately 590,000 cubic yards of cut, up to 830,000 cubic yards of fill, and approximately 1,700,000 cubic yards of remedial grading. Up to 500,000 cubic yards of dirt will be hauled to the site, which includes the 240,000-cubic-yard difference between the Specific Plan's cut and fill as well as the additional fill needed to compensate for soil shrinkage associated with soil compaction.

Section 5.0, Design Guidelines, identifies the grading guidelines that are designed to ensure development is safe, aesthetic, and cost-effective.

Additionally, grading activities will require import of dirt from southern portions of the site to northern portions of the site for the construction of the buried bank stabilization. To facilitate this action, a temporary at-grade haul route, at a width of 35 feet, will be constructed within the Vista Canyon Road Bridge corridor and used for up to nine months.

The Specific Plan cut and fill areas are shown on **Figure 3.0-1, Conceptual Grading Plan**. The off-site grading necessary to implement the Specific Plan was described above in **Section 2.3.3**, above.

3.3 DRAINAGE/WATER QUALITY

The Vista Canyon Drainage and Water Quality Plan incorporates methodologies to meet or exceed the ongoing National Pollutant Discharge Elimination System (NPDES) Permit requirements. The plan includes a comprehensive series of drainage, flood control, and water quality improvements designed to allow for a system to both protect development and preserve the Santa Clara River.

3.3.1 EXISTING CONDITIONS

The Specific Plan site consists of seven minor contributing drainage areas that independently drain *via* sheet flows and natural concentrated flows to the Santa Clara River.

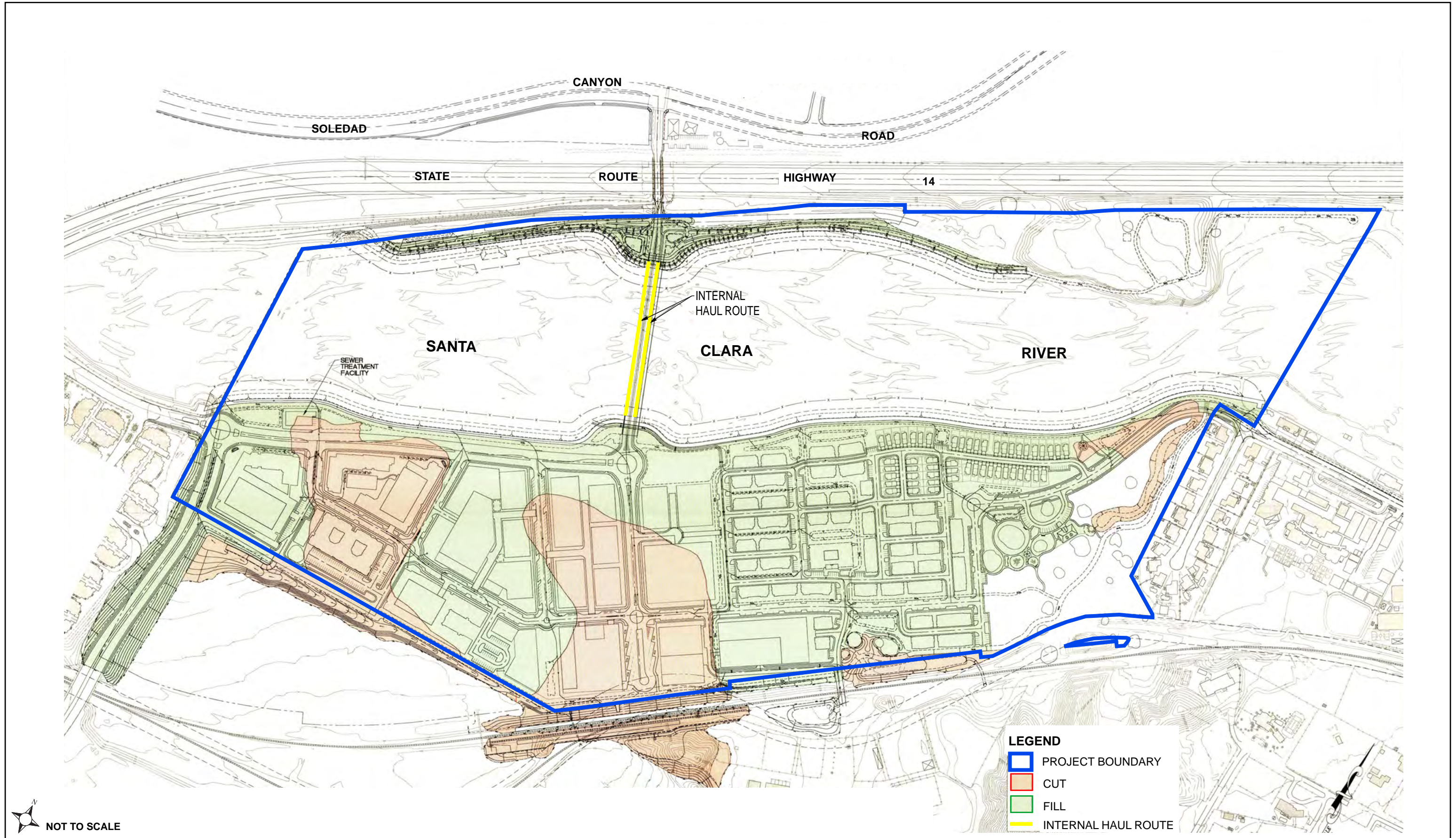

Figure 3.0-1

3.3.2 PROPOSED CONDITIONS

The Specific Plan will require construction of new drainage and water quality features to allow for a system that both protects development from erosion and potential flooding, and preserves the Santa Clara River. In addition to construction of conventional drainage improvements like storm drains, which will outlet through the north and south banks of the Santa Clara River and associated energy dissipaters (consisting of either rip-rap or other devices that reduce storm flow velocities and prevent erosion at stormwater discharge points into the River),⁴ the Specific Plan envisions using sustainable drainage and water quality technologies, such as bioretention areas, planter boxes, vegetated swales, combination bioretention swales, filter strips, permeable pavement, underground infiltration, and storage and reuse systems.

The primary objectives of the Specific Plan's drainage concept and stormwater management program are as follows:

- (a) Incorporate Low Impact Development (LID) practices wherever feasible;
- (b) Effectively manage wet and dry weather runoff water quality by limiting increases in runoff pollutants and flows at the source through Project Design Features (PDFs) and Best Management Practices (BMPs);
- (c) Avoid or minimize impacts to water quality through site design and use of sustainable drainage/water quality technologies;
- (d) Maintain and enhance the Santa Clara River Corridor in a manner that allows for the passage of the Los Angeles County Capital flood flow without the permanent removal of natural river vegetation;
- (e) Delineate the banks of the Santa Clara River so that they are outside of the "waters of the United States," as defined by Corps, and consistent with federal laws and regulations;
- (f) Where development is proposed within the existing floodplain, the land where development is to occur will be elevated and protected in accordance with applicable laws and regulations to remove it from the floodplain;
- (g) Bank stabilization will utilize state-of-the-art buried soil cement techniques, and will occur only where necessary to protect against erosion and potential flooding (*see, Section 3.4*, below); and

⁴ **Figure 3.0-2**, Drainage and Water Quality Plan, depicts the locations of the conventional storm drain outlets on both the north and south banks of the River and associated energy dissipaters. As shown, there will be a total of four storm drain outlets to the River, two on the north bank, and two on the south bank. Energy dissipaters (*e.g.*, rip-rap) will be used to slow the rate of runoff flow into the River to prevent erosion of the River channel.

- (h) Comply fully with the National Pollutant Discharge Elimination System (NPDES) permit requirements, including the County's Standard Urban Stormwater Mitigation Plan (SUSMP) requirements.

Figure 3.0-2, Drainage and Water Quality Plan, illustrates the Specific Plan's drainage and water quality plan and related improvements. The plan incorporates methodologies to meet or exceed NPDES permit and SUSMP requirements. It also includes a comprehensive series of drainage, flood control, and water quality facilities designed to allow for a system to both protect development and preserve the Santa Clara River.

The Specific Plan's drainage concept is designed to provide drainage and flood protection, and maintain stormwater flows from the Specific Plan during and after buildout. As proposed, on-site surface runoff will be conveyed to a network of treatment structures, including bioretention areas, vegetated swales, and water quality basins, prior to discharge into the River. In the PAs, parking lot and roof runoff will be directed through landscaped parkways and grassy swales, or through sections of permeable pavement, to provide initial treatment prior to discharge into the drainage system. Please refer to Section 4.2, Flood, of the EIR for a detailed discussion of existing and post-development drainage conditions and related improvements on the Specific Plan site.

The Specific Plan will incorporate PDFs to address water quality and hydrologic impacts, including site design, source control, treatment control, and hydromodification control BMPs. As currently planned, stormwater runoff from all developed areas within the Specific Plan will be routed to sustainable drainage improvements, such as bioretention areas, vegetated swales, and/or infiltration treatment control BMPs. These BMPs will be designed to receive dry weather flows, small storm flows, and the initial portion of large storm flows. Please refer to Section 4.8.1, Water Quality, of the EIR for a detailed discussion of the water quality PDFs incorporated into the Specific Plan's drainage concept and water quality plan.

The Specific Plan incorporates site design features that preserve natural areas, which facilitate SUSMP requirements. For example, over 35 acres, or 20 percent, of the 185-acre project site will remain as parks, landscaping, open space (non-River related), and/or water quality treatment areas. An additional 87 acres, or 47 percent, of the 185-acre site will consist of the Santa Clara River Corridor, buried bank stabilization, and the Santa Clara River Regional Trail. In total, approximately 60 percent of the site will be open space or recreational areas.

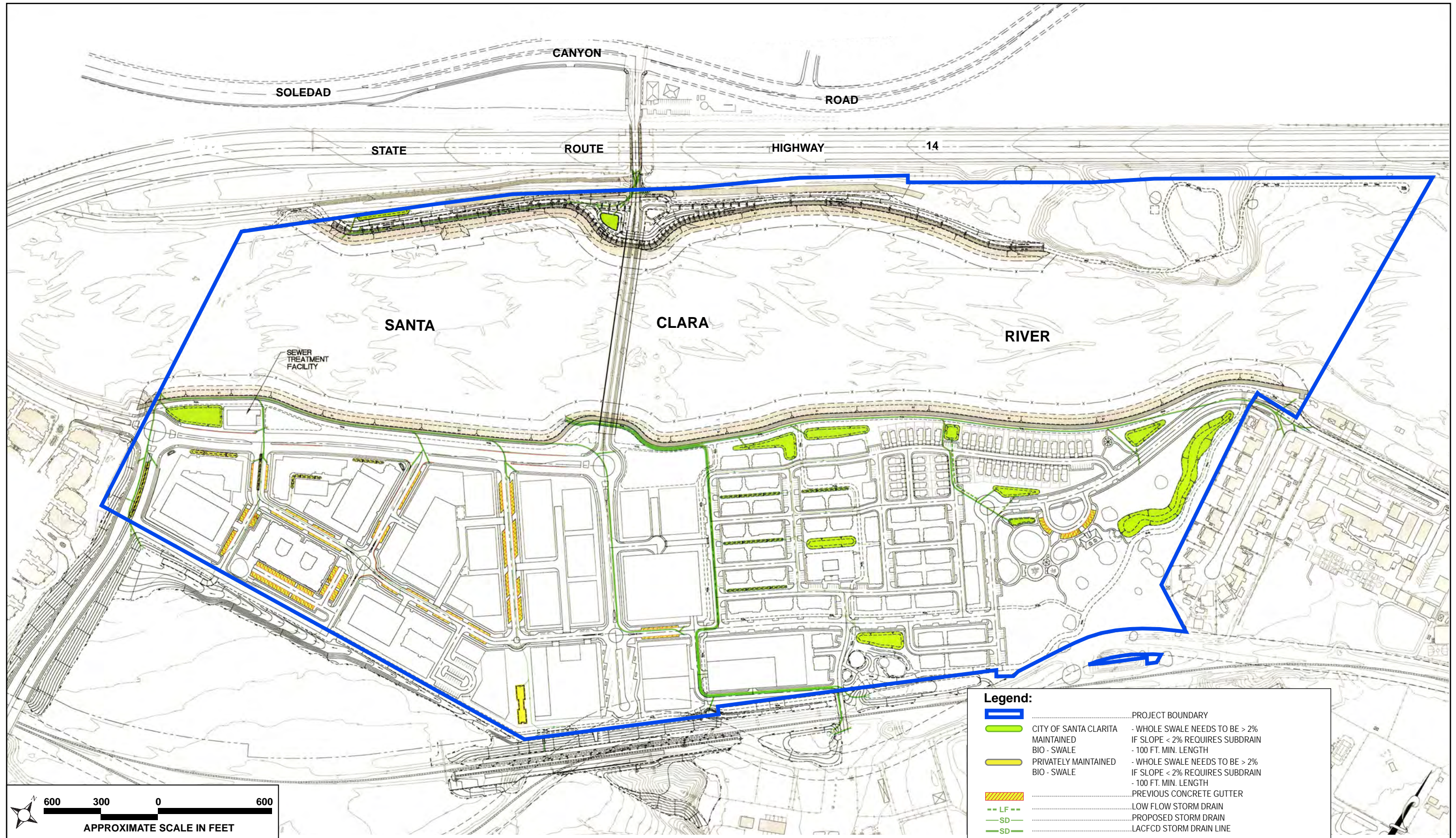

Figure 3.0-2

The Specific Plan also will incorporate numerous source control BMPs to address pollutants of concern. These practices are designed to minimize introduction of pollutants to the maximum extent practicable, and will include education programs, animal waste bag stations, street sweeping, and catch basin cleaning.

In addition, the Specific Plan will utilize LID practices and treatment control BMPs as part of the final drainage/water quality design for the project area. The primary goals of LID practices are to maintain a landscape functionally equivalent to pre-development hydrologic conditions, and to minimize the generation of pollutants of concern. LID principles include the following:

- (a) **Minimize Impervious Area/Maximize Permeability.** Principles include preserving open space areas, reducing impervious surfaces (through reduced road width, for example), using permeable paving materials, reducing land coverage of buildings by constructing multi-story structures, and incorporating bioretention and infiltration into the Specific Plan's landscape design.
- (b) **Minimize Directly Connected Impervious Areas.** Minimizing directly connected impervious areas can be achieved by directing runoff from impervious areas to vegetated areas (*e.g.*, landscaped areas, vegetated swales) or to infiltration BMPs.
- (c) **Conserve Natural Areas.** Conserving and protecting native soils, vegetation, and the River Corridor helps to mimic the project site's pre-developed hydrologic conditions. This is accomplished by constructing multi-story development within portions of the Specific Plan site to conserve open areas, planting additional vegetation, using native and/or non-native/non-invasive vegetation in parking lot areas and other landscape areas, and preserving, restoring, and enhancing riparian areas and wetlands within the Santa Clara River Corridor.
- (d) **Select Appropriate Building Materials.** Use of appropriate building materials (*e.g.*, roof gutters and downspouts without copper or zinc) reduces the generation and discharge of pollutants of concern in runoff; and, therefore, acts as a source control BMP.
- (e) **Protect Slopes and Channels.** Protecting slopes and channels reduces the potential for erosion and preserves natural sediment supply.

Further, the Specific Plan will incorporate numerous treatment control BMPs that are designed to remove pollutants once mobilized by rainfall and runoff. These treatment control BMPs include the following:

- (a) **Bioretention.** Bioretention areas are vegetated (*i.e.*, landscaped) shallow depressions that provide storage, infiltration, and evapotranspiration. Bioretention areas also remove pollutants by filtering stormwater through plants adapted to the local climate and soil

moisture conditions and an engineered soil mix. Bioretention will be considered for use, wherever feasible, as part of the Specific Plan's landscaping plan.

- (b) **Planter Boxes.** Planter boxes are much like bioretention, with a soil media layer, a gravel drainage layer, and vegetation. Like bioretention, planter boxes provide storage, filtration, and evapotranspiration, and remove pollutants via filtration. However, unlike many bioretention, planter boxes typically are underlain by an impervious layer and not designed to infiltrate water. This allows planter boxes to be placed in areas where infiltration is prohibited. Planter boxes may be designed without a bottom where infiltration is permissible.
- (c) **Vegetated Swales.** Vegetated swales treat stormwater runoff through both vegetative treatment and infiltration. Swales treat the water quality design flow as the runoff sheet-flows through grassy vegetation on the swale surface, removing pollutants by filtering stormwater through plants adapted to the local climate and soil moisture conditions. Incidental infiltration occurs into native soil when water is present. Plants utilize soil moisture and promote the drying of the soil through transpiration, thereby promoting volume reduction.
- (d) **Combination Bioretention Swales.** Combination bioretention swales have attributes of both bioretention areas and vegetated swales, as described above. Bioretention swales have all the attributes of a bioretention area, but do not include an underdrain. Runoff is stored in the pores of the amended soil and in shallow surface ponding and exfiltrates into native soil over a period of days. Bioretention swales are linear in shape, have dense vegetation that protrudes above the maximum water surface elevation, and are configured with the inlet and outlet at opposite ends to promote flow through the length of the facility.
- (e) **Filter Strips.** Filter strips treat stormwater runoff through both vegetative treatment and infiltration. Runoff from impervious surfaces sheet flows in a very shallow layer through grassy vegetation, removing pollutants by filtering stormwater through plants adapted to the local climate and soil moisture conditions. Incidental infiltration occurs into native soil when water is present. Plants utilize soil moisture and promote the drying of the soil through transpiration thereby promoting volume reduction.
- (f) **Permeable Pavement.** Permeable pavements contain small voids that allow water to pass through to a stone base. They come in a variety of forms; they may be a modular paving system (concrete pavers, grass-pave, or gravel-pave) or poured in place solutions (porous concrete, permeable asphalt). All permeable pavements include an aggregate reservoir to retain and infiltrate water. An overflow pipe generally is installed near the top of this aggregate layer to ensure that water does not pond on the surface of the pavement. While conventional pavement results in increased rates and volumes of

surface runoff, permeable pavements, when properly constructed and maintained, allow some of the stormwater to percolate through the pavement and enter the soil below.

- (g) **Underground Infiltration Gallery.** Underground retention and infiltration galleries operate by storing and infiltrating water below roadways or other surfaces. These may consist of a thick layer of aggregate providing storage volume in pore space. Alternatively, underground retention products are available that provide storage capacity and promote infiltration, often more efficiently than aggregate reservoirs.
- (i) **Infiltration Trench.** Infiltration trenches are rock-filled trenches designed specifically to store stormwater during a storm and exfiltrate it into surrounding soils over a period of days. Infiltration trenches are used in areas with high infiltration rates and limited space.
- (j) **Dry Wells.** Dry wells are much like infiltration trenches but may be installed deeper in the soil profile to specifically promote infiltration into highly infiltrative soil layers.
- (k) **Storage and Reuse.** Storage and reuse systems may take a variety of forms, but most typically consisting of cisterns or rain barrels connected to a roof gutter system. Roof runoff is captured and stored, thereby reducing runoff, making water available for non-potable uses such as irrigation, and reducing overall water usage.

Conceptual illustrations of the treatment control BMPs described above are shown on **Figures 3.0-3 and 3.0-4.**

The Specific Plan also will utilize a series of hydromodification control measures to prevent and control hydromodification impacts to the Santa Clara River, including: (a) avoiding, to the extent feasible, the need for mitigation of hydromodification impacts by preserving natural hydrologic conditions and protecting sensitive hydrologic features, sediment sources, and sensitive habitats within the Santa Clara River Corridor; and (b) minimizing the effects of development through low impact/site design practices, and implementation of treatment control BMPs.

In addition, the Specific Plan's development footprint will allow for natural stream channel activity. This includes maintaining set backs to allow for natural river channel movement and adjustment in response to changes in energy associated with runoff and larger storm events. The engineered structural elements that will be implemented where needed for Santa Clara River stability include energy dissipation and buried bank stabilization:

- (a) **Energy Dissipation.** Energy dissipation at storm drain outfalls provides erosion protection in areas where discharges have the potential to cause localized stream erosion. Erosion protection will be provided at all storm drain outlets to the Santa Clara River.

- (b) **Buried Bank Stabilization.** The Specific Plan will include buried bank stabilization along the Santa Clara River within the site. The proposed bank protection will consist of buried soil cement to provide scour and freeboard flood control protection. Soil cement is a state-of-the-art flood control technique used to protect against erosion while maintaining natural vegetation and soft banks. Soil cement will be buried below the existing banks of the Santa Clara River. Disturbed areas will then be re-vegetated with native plant species, maintaining or improving the natural habitat presently found along the River (*see*, **Section 3.4**, below).

3.4 BANK PROTECTION/STABILIZATION

3.4.1 EXISTING CONDITIONS

The Specific Plan site is located within the Santa Clara River Hydrologic Basin and associated watershed, which is approximately 1,634 square miles in area. The portion of the Santa Clara River watershed located generally upstream or east of the Specific Plan site is approximately 191 square miles in size. (PACE, 2009.) The upstream watershed drains portions of the Angeles National Forest from the north, south, and southeast, which comprises approximately 40 percent of the watershed area at this location. The Specific Plan site, consisting of approximately 185 acres, represents 0.15 percent of the 191-square-mile upstream watershed, and 0.018 percent of the entire approximately 1,634-square-mile Santa Clara River watershed.

Within the Specific Plan site, the Santa Clara River is generally dry, except after periods of heavy rainfall, generally occurring during the winter months. (Dudek, 2009.) As a result, flows in the Santa Clara River, like most Southern California rivers, are highly episodic. These large episodic events are associated with occasional storm events, generally in the winter months, and have a significant effect on the existing geomorphic characteristics of the Santa Clara River mainstem.

The portion of the Santa Clara River within the Specific Plan site conveys runoff from precipitation in the upper watershed, as well as urban runoff during storms from the developed portion of the watershed. The River's active channel width within the Specific Plan site ranges from approximately 28 to 64 feet. A majority of the Santa Clara River within the site also is characterized by existing earthen banks that have been realigned over time due to storms, and a streambed that displays evidence of some aggradation and degradation. The stretch of the Santa Clara River within the site also is characterized by a wide, meandering channel that supports vegetated and un-vegetated islands of varying size, composition, and age that have developed both within and outside the bank or active channel. (Dudek, 2009.)

Plan View

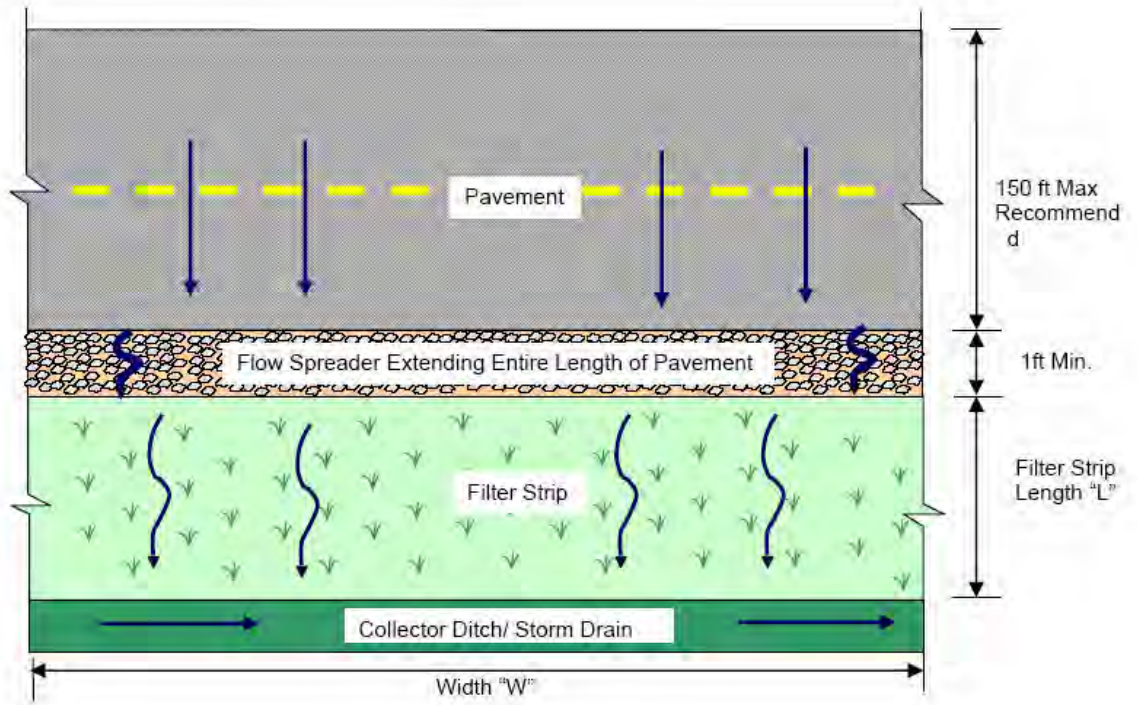

Profile

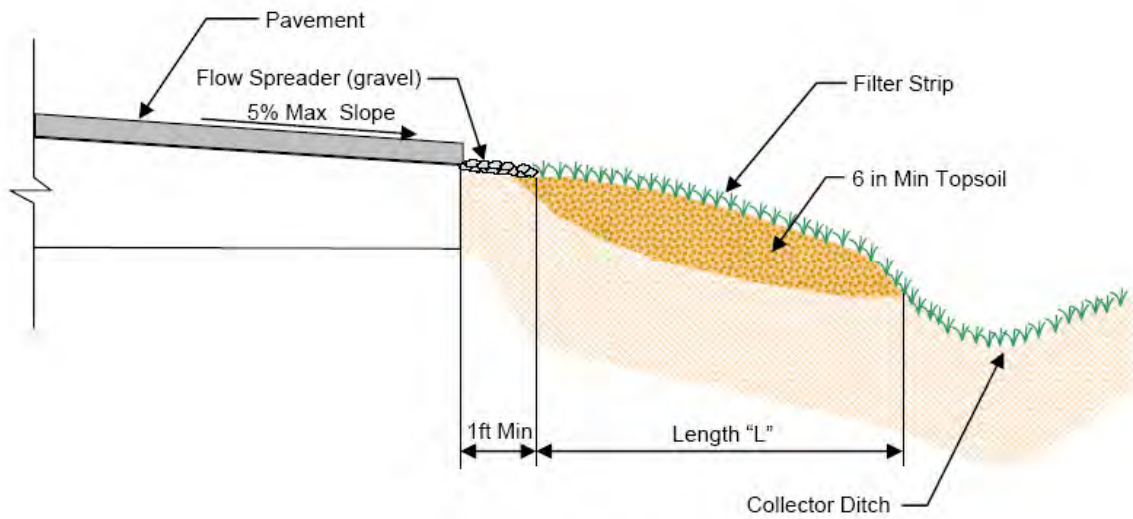

NOT TO SCALE

FIGURE 3.0-3

Conceptual Illustration of Treatment Control BMPs

Plan View - Parking lot example

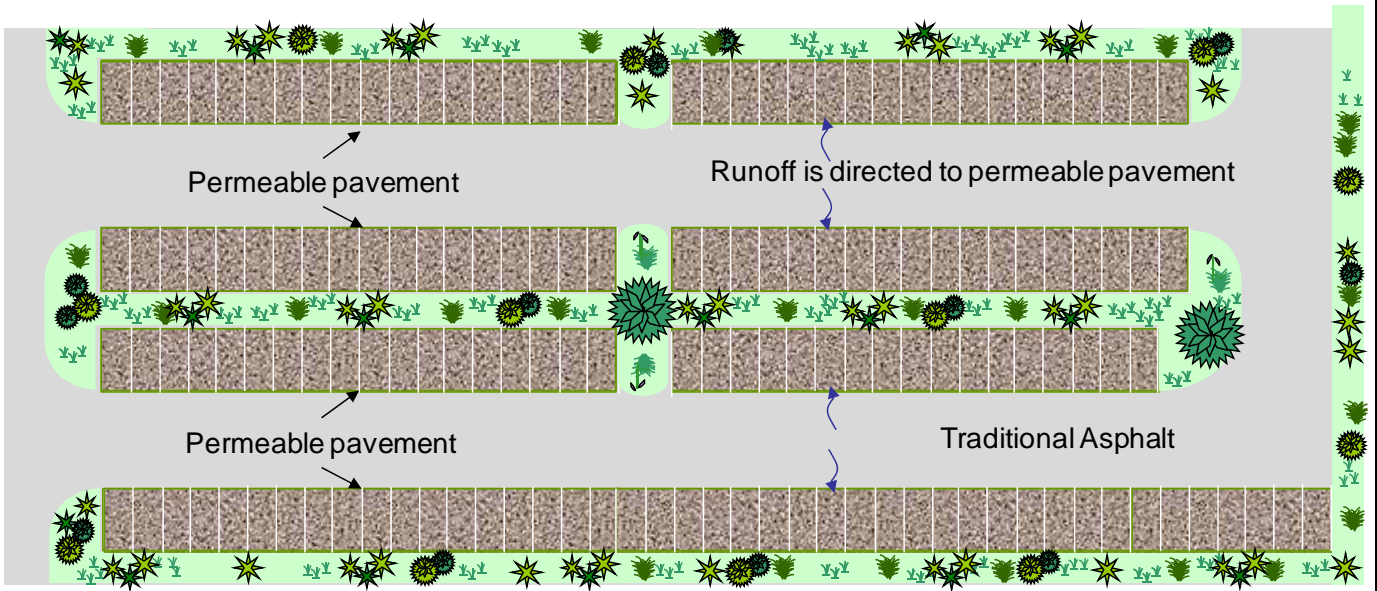

Profile

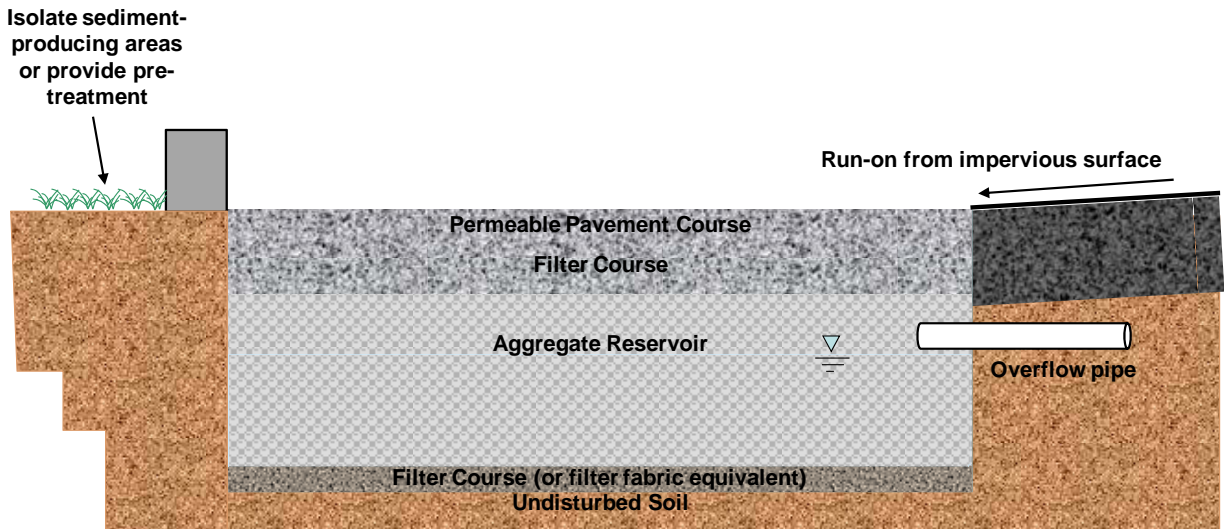

NOT TO SCALE

FIGURE 3.0-4

Conceptual Illustration of Treatment Control BMPs

Within the Specific Plan site, there are existing flood control improvements consisting of debris fencing along portions of both the north and south side of the active channel and rip-rap from the Lost Canyon Road/SR-14 undercrossing extending westerly to the Specific Plan boundary. The Specific Plan will remove these existing flood control improvements and replace them with buried bank stabilization. (See **Figure 2.0-23, Existing Santa Clara River Within Project and Vicinity**, for an aerial overview of the River upstream and downstream from the Specific Plan site.)

3.4.2 PROPOSED CONDITIONS

The Specific Plan includes installation of buried bank stabilization along portions of the Santa Clara River within the project site to protect development from flood hazards while preserving the River as a natural resource. The buried bank stabilization will be designed and constructed to retain the Santa Clara River's significant riparian habitat, to allow the River to continue to function as a regional east-west wildlife corridor, and to provide flood protection pursuant to Federal Emergency Management Administration (FEMA) and Los Angeles County/City of Santa Clarita standards. As indicated previously, portions of the site are within the existing FEMA 100-year floodplain. Therefore, the Specific Plan triggers FEMA review in the form of the CLOMR/LOMR floodplain map revision process; FEMA issued the CLOMR approval in November 2009 (see EIR **Appendix 4.2** [letter from FEMA, dated November 13, 2009].) The proposed Specific Plan's buried bank stabilization extends along both sides of the Santa Clara River within the Specific Plan site.

The soil cement bank protection on the north bank of the Santa Clara River is located south of SR-14. The alignment begins at the westerly edge of the Mitchell Hill Open Space area. Mitchell Hill is an exposed bedrock formation that is approximately 40 feet above the elevation of the River and, based upon its geologic formation, does not require river bank erosion protection. The north bank extends approximately 3,000 linear feet from Mitchell Hill downstream and terminates near the project site's northwest boundary, adjacent to SR-14. The bank protection is designed to protect the north bank against potential erosion and flooding, and also is necessary to protect the Vista Canyon Road Bridge north abutment from erosion and flooding. Portions of the north bank stabilization will replace existing rip-rap flood control improvements, generally located west of the existing Lost Canyon Road/SR 14 undercrossing.

The soil cement bank protection on the south bank of the Santa Clara River is located between the easterly site boundary near existing La Veda Avenue and the westerly site boundary near the existing Colony Townhomes. The south bank is approximately 4,500 linear feet with the horizontal alignment extending from approximately 1,400 feet downstream of Sand Canyon Bridge to 1,100 feet upstream of the SR-14 Bridge. The bank protection is designed to protect the Specific Plan site and the southerly abutment of the Vista Canyon Road Bridge from potential erosion and flooding.

The bank protection on the north and south banks also will result in the removal of debris fencing along both sides of the active channel on portions of the project site. The bank stabilization will consist of an 8-foot-wide soil cement section with varied height (top and toe as required by the City/County) and a maximum 1.5:1 slope. Once installed, the soil cement will be backfilled (buried) with native soils on a 3:1 or flatter slope. The excavation required to construct the bank protection will be backfilled and returned to existing grade, except as overlaid by the 3:1 or flatter fill slope. The final slope will be revegetated with native species and temporarily irrigated until the vegetation is established.

Four storm drains, two through the north bank and two through the south bank, also are proposed to outlet via reinforced concrete pipe. To reduce storm flow velocities and prevent erosion at stormwater discharge points into the Santa Clara River, energy dissipaters consisting of either rip-rap or other reinforced concrete impact-type energy dissipaters will be constructed at storm drain outlets into the River.

The advantages of buried soil cement over other types of bank stabilization include the following:

- (a) Allows for natural revegetation of areas above the buried soil cement;
- (b) Uses on-site native soils, which reduce hauling requirements and associated impacts;
- (c) Requires a smaller structural footprint, which reduces the potential for disturbance of adjacent areas; and
- (d) The thickness of the soil revetment requires little or no maintenance and inspection.

Figure 3.0-5 provides a cross section of the conceptual design of the buried soil cement/bank stabilization, and its relationship to a typical trail section. **Figure 3.0-6** depicts the soil excavation and backfill process associated with installation of buried soil cement/bank stabilization. The original channel elevation will be restored after construction, and riverbed habitat areas will be revegetated with native plant species. The buried soil cement will not be visible, and the land above it will be used as upland habitat, just as it was used before buried bank installation. **Figure 3.0-7**, shows photographs of an area after completion of soil cement/buried bank stabilization and the restored revegetation area. This figure also depicts the relationship between the Santa Clara River, buried bank stabilization, and a trail area. The representative photographs used in this figure are taken from previously constructed projects located in the Valencia community, in which buried bank stabilization was successfully used.

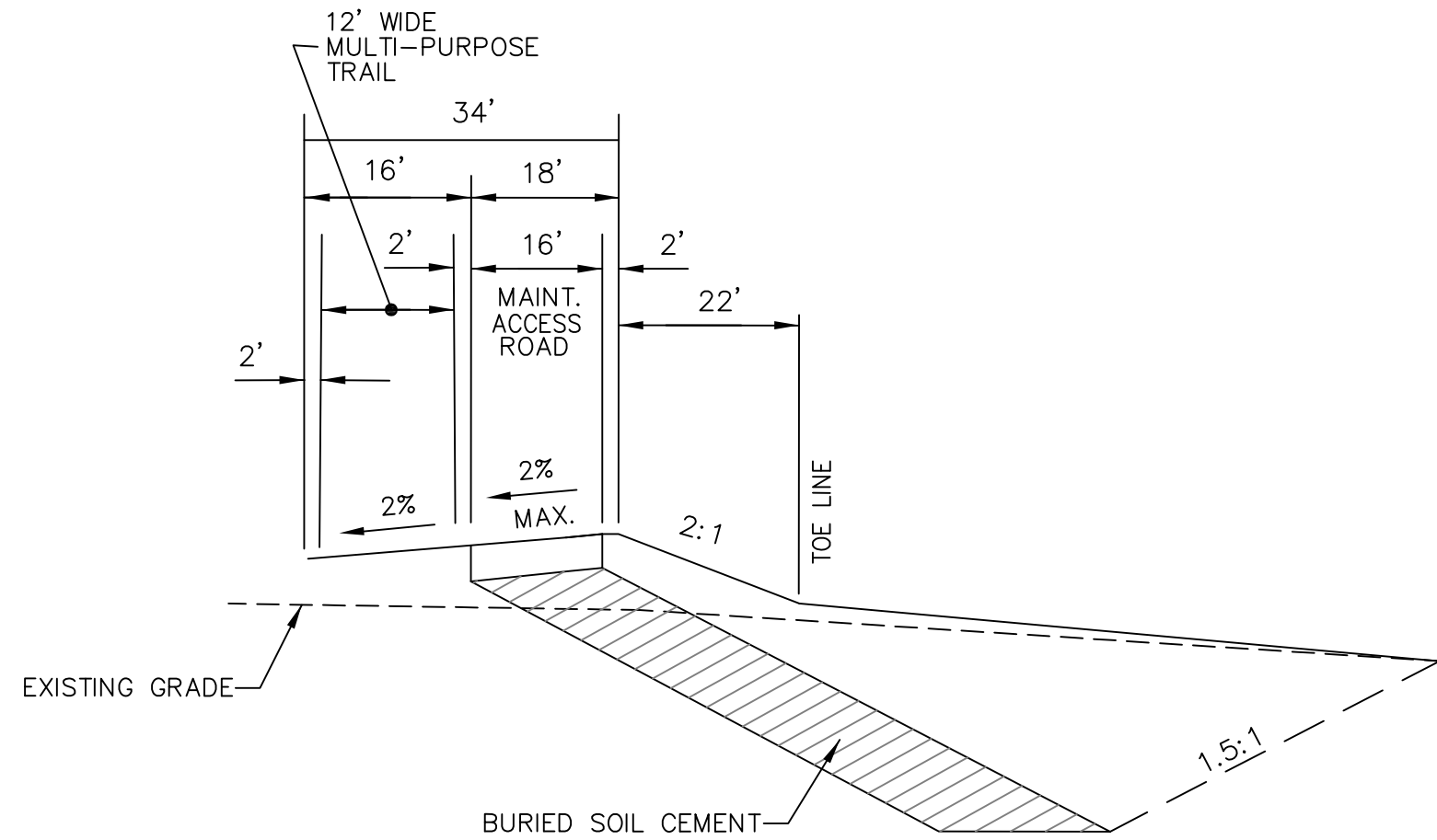

SECTION A-A *
TYPICAL SECTION-BANK STABILIZATION
 NOT TO SCALE

NOT TO SCALE

* SEE THE VTTM FOR
 ACTUAL CROSS-SECTION LOCATION

Figure 3.0-5

Cross-Section of Conceptual Design of Buried Bank Stabilization Relative to Typical Trail Section

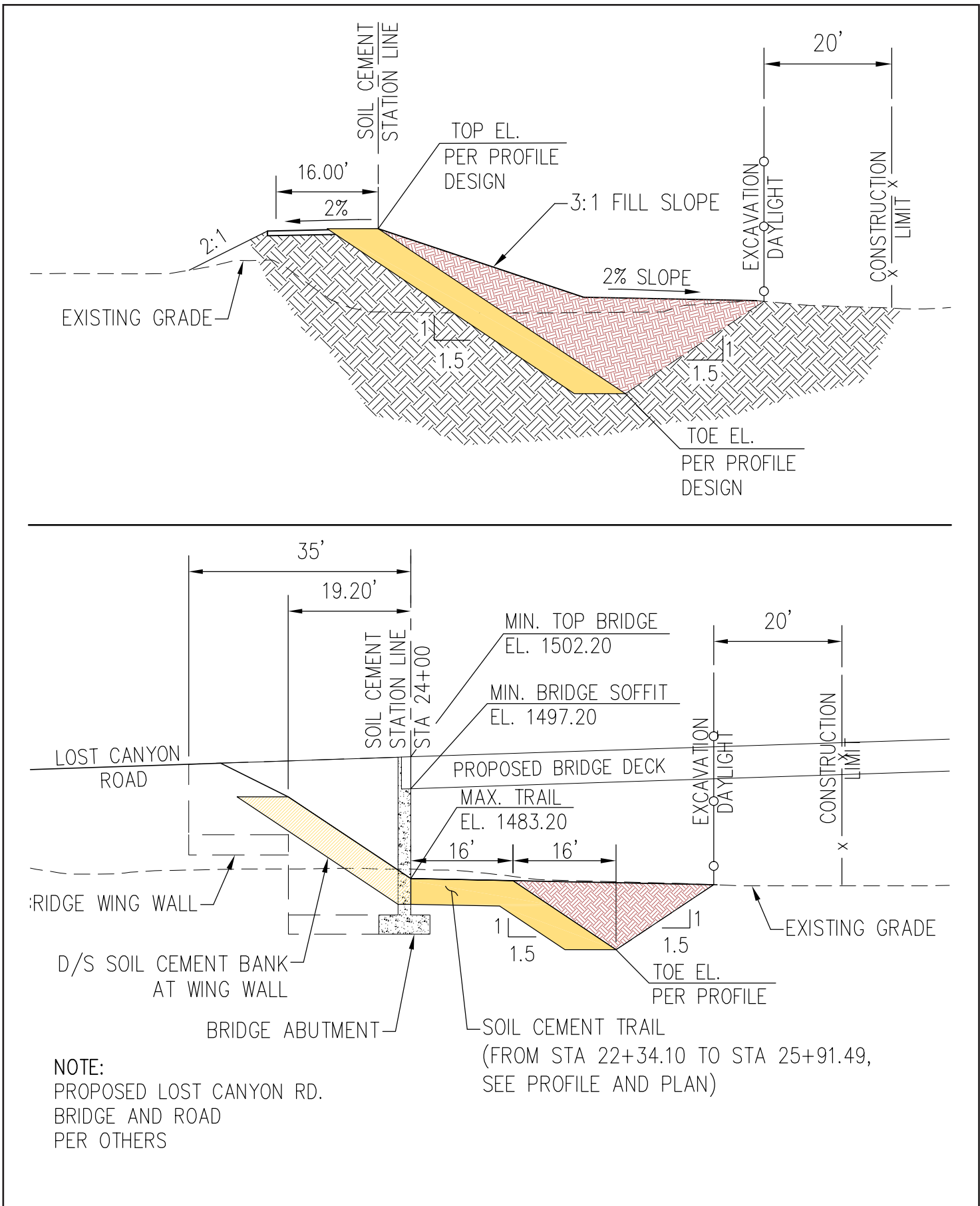

Figure 3.0-6

Soil Excavation and Backfill Process



Photo 1



Photo 2



Photo 3



Photo 4



Photo 5



Photo 6

Photo 1-5 : Bank Stabilization at Creekside
Photo 6 : Bank Stabilization at Bridgeport
(These photos depict Buried Bank stabilization)

The majority of the bank protection will be located outside of or adjacent to the existing riparian corridor in areas that typically will experience storm flow velocities much less than the main River channel velocities (*e.g.*, typically velocities of 2-8 feet per second (fps) occur along the banks while velocities greater than 15 fps in the main channel occur adjacent to these locations during a 100-year storm event). (PACE Memorandum, May 2007.) Lower, non-erosive velocities in the areas along buried bank stabilization indicate that it is unlikely that all or part of the buried bank stabilization will become exposed. (PACE Memorandum, May 2007.)

3.5 WATER SERVICE/RECYCLED WATER

3.5.1 EXISTING CONDITIONS

The Specific Plan site currently is mostly undeveloped; as such, most of the site is not served by water or recycled water facilities. There are two existing water supply wells within the site in the Santa Clara River Corridor. These water supply wells are owned and operated by the Santa Clarita Valley Water Division of Castaic Lake Water Agency (CLWA). As indicated previously, one of the wells would be removed during Specific Plan implementation.

3.5.2 PROPOSED CONDITIONS

Based on detailed water demand estimates prepared for the project, the Specific Plan will generate a total water demand of 333.7 acre-feet per year (afy), 201.6 afy of potable water demand, and 132.1 afy of non-potable demand. Potable water demand (201.6 afy) will be met by the Santa Clarita Water Division (SCWD), the retail water supplier of CLWA, through a combination of State Water Project (SWP) water delivered through CLWA and local groundwater from wells located primarily in the Alluvial aquifer. The Alluvial aquifer and the Saugus Formation comprise the two-aquifer system known as the Santa Clara River Valley Groundwater Basin, East Subbasin (Basin), located in the Santa Clarita Valley. The amount delivered from each source varies year-to-year due to hydrologic and other conditions. Non-potable water demand (132.1 afy) will be met through use of recycled water from the Vista Canyon WRP, located adjacent to the western boundary of the Specific Plan, directly north of Lost Canyon Road.

Figure 3.0-8 depicts the on-site potable and non-potable water system and associated infrastructure to serve the Specific Plan. As shown on **Figure 3.0-8**, the potable water delivery system consists of a network of varying sized water mainlines that generally follow major roadways. A network of smaller lines would be located within the planned roadway network would distribute the water for connection to laterals located on individual lots. Potable water storage will come from the existing SCWD infrastructure system.

The Specific Plan's WRP will be sized to treat approximately 395,411 gallons per day (gpd), and will be owned and operated by the City of Santa Clarita. As such, it will be considered a "municipal wastewater treatment plant" or publicly owned treatment work (POTW). The

Specific Plan site is not currently within the boundary of the Santa Clarita Valley Sanitation District, but is within the SCWD service boundaries. The project applicant or designee will construct the WRP in conjunction with the Specific Plan, and provide a turnkey facility to City. The City will likely contract for operation of the WRP, and all costs associated with the ongoing maintenance of the plant will be paid for by future residents and property owners within the property through the formation of an assessment district.

3.6 WASTEWATER SERVICE

3.6.1 EXISTING CONDITIONS

The Specific Plan site is mostly undeveloped, and will require wastewater infrastructure to serve the site. Because the Specific Plan site is surrounded by existing development, the provision of wastewater services to the site will not require considerable extension of distribution infrastructure.

3.6.2 PROPOSED CONDITIONS

The Vista Canyon WRP will treat the wastewater generated by both the project and a portion of the existing flows from a City of Santa Clarita sewer line crossing the project site. All solids from the WRP will be sent to the Santa Clarita Valley Sanitation District's existing Valencia WRP for processing and disposal. Recycled water from the WRP will be delivered to CLWA as the wholesale water agency for the Santa Clarita Valley to offset existing water demands. This water will be distributed by CLWA through its reclaimed water distribution system both within and outside of the project boundary. Initially, some of the water may be directed to the percolation pond, or infiltration basin, adjacent to the WRP until the CLWA recycled system is operational.

3.7 DRY UTILITIES

3.7.1 EXISTING CONDITIONS

The Specific Plan site currently is mostly undeveloped, and will require electric, natural gas, and telecommunication infrastructure to serve the project. Because the Specific Plan site is surrounded by existing development, the provision of electricity, natural gas, and telecommunication services to the site will not require considerable extension of distribution infrastructure.

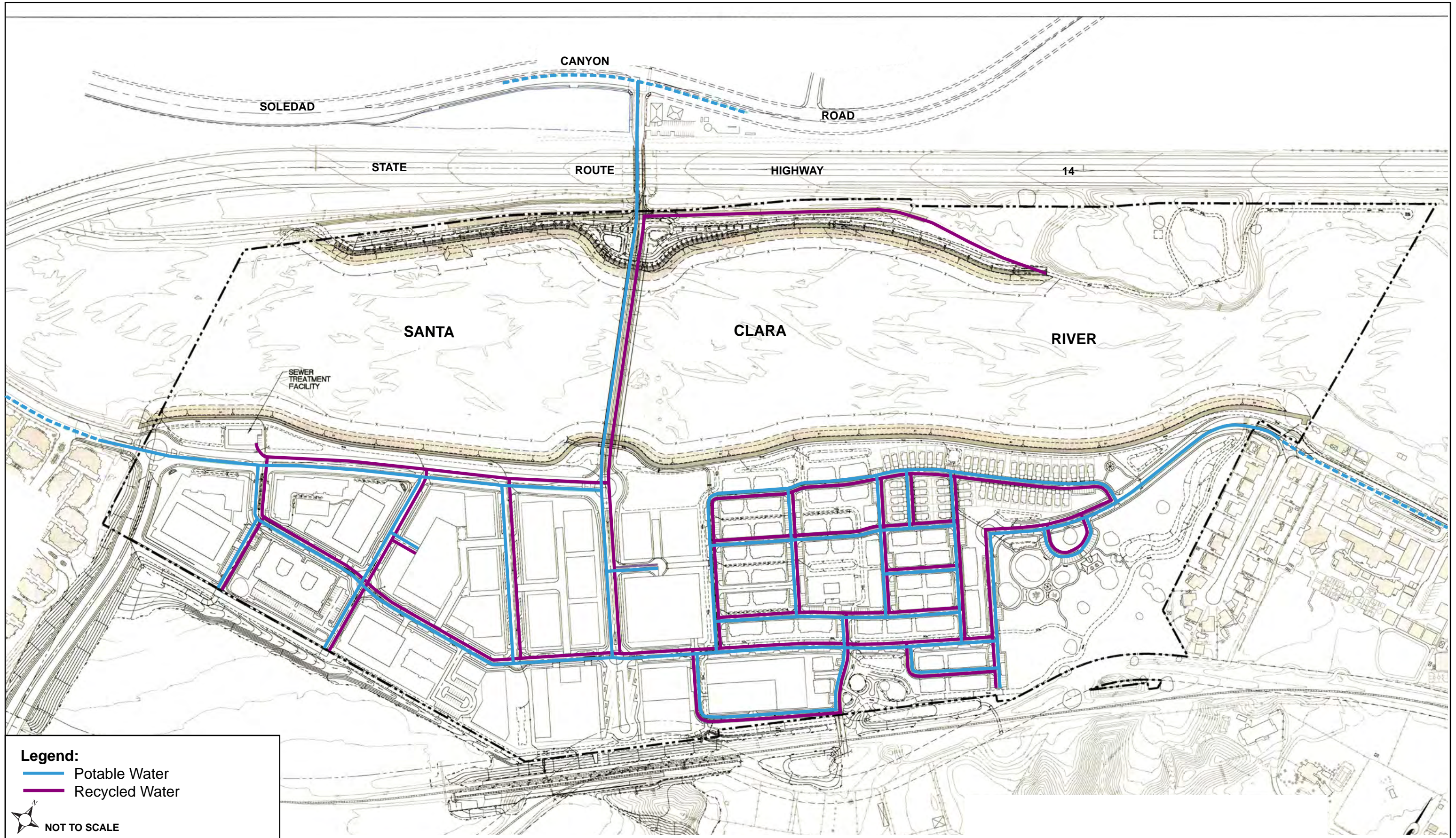

Figure 3.0-8

Conceptual On-Site Potable and Non-Potable Water Systems

3.7.2 PROPOSED CONDITIONS

As discussed in further detail below, electric, natural gas, and telecommunication infrastructure will be installed to serve the Specific Plan. These "dry" utilities will be located within underground conduits in the public or private street corridors/rights-of-way in general conformance with the phasing of the Specific Plan. Consultation with all appropriate utilities to determine the extent of the "dry" utilities needed to serve the site will be required prior to and during the final infrastructure/improvement plan stages.

With respect to electricity, the Specific Plan site is located within the Southern California Edison service area. Primary service will come from Soledad Canyon Road via the existing power lines that presently cross the River and the site. This existing line will be extended to serve the Specific Plan's initial development phases. Upon its construction, power lines will be placed within the Vista Canyon Road Bridge. Additionally, service lines exist within Lost Canyon Road to the southwest and Lost Canyon Road at La Veda Avenue to the east, both of which will likely be extended into the site.

Phone service will be provided by AT&T. Primary service will come from Soledad Canyon Road via the existing line that crosses the River and the site, which will be placed in the Vista Canyon Road Bridge upon its construction. Telephone lines will be constructed underground throughout the site within phases as development commences. Existing service lines are also located within Lost Canyon Road in the southwest corner of the site and Lost Canyon Road near La Veda Avenue. These localized lines may also be extended to the site and utilized for the early phases of the project.

The Specific Plan site is within the Time Warner cable service area. Existing service lines are located in Soledad Canyon Road to the north, Jakes Way to the west, and Lost Canyon Road to the east. A main line feeder from Soledad Canyon Road will be placed in the Vista Canyon Road Bridge. Existing service lines are also located within Lost Canyon Road in the southwest corner of the site and Lost Canyon Road near La Veda Avenue. These localized lines may be utilized for the early phases of the project.

As to natural gas, the Specific Plan site is within the Southern California Gas Company service area. Existing service lines are located in Soledad Canyon Road to the north, Lost Canyon Road to the southwest, and Lost Canyon Road near La Veda Avenue to the east. Gas service to the site will be extended from one of these existing sources. A gas line will also be placed into the Vista Canyon Road Bridge.

3.8 ROADWAY DESIGN

3.8.1 EXISTING CONDITIONS

This section presents the existing condition of the roadways, transit, bicycle, and pedestrian circulation within the Specific Plan site and the surrounding study area.

First, this section describes the freeway, arterials, and local streets that will provide access to the Specific Plan site.

Freeways. SR-14 (Antelope Valley Freeway) is a north-south freeway that extends from I-5 in northern Los Angeles County through Santa Clarita and into the Antelope Valley. It provides regional access to and from the Specific Plan's northern boundary.

Major Highways. Five "Major Highways," which are six or more lane arterials designed for high mobility and limited vehicular access to driveways and cross streets, are within the Specific Plan's study area. Soledad Canyon Road, a four to six-lane major highway, parallels SR-14 in the eastern area of the Santa Clarita Valley. It also provides regional access to and from the Specific Plan's northern boundary. Lost Canyon Road (Via Princessa to Jakes Way), a four-lane divided major highway, provides access to and from the Specific Plan's southwestern boundary. Sand Canyon Road (Soledad Canyon Road to Lost Canyon Road), a north-south major highway with up to two travel lanes in each direction, provides access to and from the Specific Plan's eastern boundary. Via Princessa (Lost Canyon Road to current western terminus of property), a four-to six-lane major highway, provides access to and from the Specific Plan's western boundary. Sierra Highway, generally a north-south major highway that parallels SR-14 from Palmdale/Lancaster southerly to I-5, provides secondary regional access through Soledad Canyon Road to the Specific Plan's northern boundary.

Secondary Highways. Five "Secondary Highways," which are arterials planned for an ultimate of four lanes and designed for high mobility and limited vehicular access to driveways and cross streets, are within the Specific Plan's study area. Sand Canyon Road (Soledad Canyon Road to Sierra Highway), a two-lane north-south arterial roadway, provides northeasterly access to the Specific Plan site. Canyon Park Boulevard, which begins at Lost Canyon Road and extends under SR-14 to Sierra Highway, is a four-lane divided arterial that provides regional access to the Specific Plan's southwestern boundary. Lost Canyon Road (west of Sand Canyon Road), a two-lane undivided roadway, currently terminates just west of La Veda Avenue, providing direct access to the Specific Plan's easterly boundary. Placerita Canyon Road (Sierra Highway to Sand Canyon Road), a four-lane divided arterial from Sierra Highway to just east of SR-14, where it becomes a two-lane undivided road, provides regional access through Sand Canyon Road to the Specific Plan's southeasterly boundary. Via Princessa (Lost Canyon Road to Golden Valley Road), a four-lane arterial, provides access through Lost Canyon Road to the Specific Plan's western boundary.

Limited Secondary Highways. Two "Limited Secondary Highways," which are two-lane streets with more limited mobility and greater access to adjacent land uses, are within the Specific Plan's study area. Jakes Way, which extends easterly from Canyon Park Boulevard under SR-14 to access the existing Colony Townhomes, provides access to the Specific Plan's southwestern boundary. Sand Canyon Road (Lost Canyon Road to Placerita Canyon Road), a two-lane, north-south undivided highway, provides access to the Specific Plan's eastern boundary.

Second, this section describes the existing public transportation services in the Specific Plan's study area. Transit in the vicinity of the Specific Plan area consists primarily of the Metrolink commuter rail line and the City's bus service.

Metrolink is a commuter rail service that operates in Southern California. The major hub is Union Station in downtown Los Angeles. Metrolink provides service between Lancaster and Union Station on the Antelope Valley Line, with three stops in the Santa Clarita area, including the existing Via Princessa station. The Via Princessa Metrolink station provides commuter rail access to the eastern and northeastern portions of Santa Clarita and adjacent areas of unincorporated Los Angeles County. The Santa Clarita and Newhall stations serve the western, southern, and northern areas of the City. Based on survey data, 80 percent of Metrolink riders reside in residential locations north and east of the Via Princessa Station. (Fehr & Peers, May 2009.) In addition, the data shows that, among the surveyed riders, downtown Los Angeles and its environs (54 percent) were the most common destinations, followed by Burbank (35 percent) and Glendale (8 percent).

Santa Clarita Transit provides fixed route transit service throughout the City and in adjacent unincorporated areas. The system encompasses eight local-serving routes as well as four "Station Link" routes that serve the Santa Clarita Metrolink station. Currently, no bus stops exist within 0.25 mile of the Specific Plan site. The closest existing stop (Route 6) is at the Soledad Canyon Road/Lost Canyon Road intersection. Routes 1, 2, and 5 stop at the Sierra Highway/Soledad Canyon Road intersection.

Finally, this section describes the existing bicycle and pedestrian system within the City, which is part of the City's non-motorized transportation schematic and continues to play a key role in future development.

Currently, there are three different classifications for bicycle facilities: (a) Class I Bike Path, which is an exclusive, two-way path for bicycles that is completely separated from a street or highway; (b) Class II Bike Lane, which is a signed and striped one-way lane on streets or highways, typically at the edge of the pavement, with the lane demarcated for bicyclists within the roadway right-of-way; and (c) Class III Bike Route, in which the bicyclist shares the right-of-way with vehicles (the lane may be signed, but is not exclusively striped for use by bicyclists).

The Santa Clara River Regional Trail includes a bike path (Class I) that begins at the northern boundary of the Specific Plan site and parallels the Santa Clara River westerly to and beyond

Whites Canyon Road. Class I paths also are provided along segments of Soledad Canyon Road, Golden Valley Road, and Sand Canyon Road. Class II bicycle lanes are present on Soledad Canyon Road west of Sand Canyon Road.

Santa Clarita's existing pedestrian network is comprised of sidewalks, paseos, and multi-use trails. Within the immediate Specific Plan vicinity, pedestrian facilities are limited to sidewalks on portions of streets and cross walks at intersections.

Based on a literature review, the following conclusions have been drawn that are relevant to the Specific Plan:

- (a) Current Metrolink rail service frequencies will support moderate levels of ridership during peak periods, and lower levels during off-peak periods;
- (b) The Specific Plan's Metrolink Station will attract ridership not only from the project site, but also from adjacent residential areas located on Jakes Way and Lost Canyon Road, which are within a 0.5-mile walk of the proposed station;
- (c) The provision of a Bus Transfer Station within the Specific Plan will tend to increase rail ridership at the proposed station and decrease external vehicle trips;
- (d) Metrolink will provide a time-competitive alternative to the automobile for peak hour (directional) travel between the Specific Plan site and destinations in Burbank, Glendale, and Los Angeles (Union Station);
- (e) Higher levels of transit usage are expected over the long term as the Specific Plan is built out; and
- (f) Even if rail or bus service was not an integral part of the Specific Plan, the Specific Plan's density, diversity of land uses, and site design, which accommodates non-automobile travel modes, will result in reductions in vehicle trips when compared to the "standard trip rates" used for the Santa Clarita Valley. (Fehr & Peers, May 2010.)

3.8.2 PROPOSED CONDITIONS

3.8.2.1 Objectives

The Specific Plan's Mobility Plan, which is contained in **Section 2.4** of the Specific Plan, identifies the transportation/circulation network to serve the Specific Plan. The Mobility Plan incorporates vehicular and non-vehicular modes of transportation in a system of roads, bike lanes, trails, and pedestrian pathways. It also illustrates the extension of transit and bicycle/pedestrian facilities to and from the Specific Plan site. The purpose of this section is to

identify the Specific Plan's roadway design objectives. The three interrelated roadway design objectives are as follows:

- (a) To provide an efficient roadway and pedestrian network connecting the Specific Plan with surrounding uses and the City's existing trails network;
- (b) To calm vehicle speeds, which creates a safe environment for pedestrians, bicycles, automobiles, service and delivery vehicles; and
- (c) To facilitate and encourage transit use as an alternative to automobiles by providing land and partnering with the City and Metrolink on rail and transit facilities to be located along the Specific Plan's southern boundary in PA-2.

The Specific Plan's roadway/circulation design meets these objectives by:

- (a) Proposing streets designed to establish a safe and efficient vehicle, bicycle, and pedestrian network, while at the same time creating a high-quality environment consistent with the proposed residential and mixed use architectural themes throughout the Specific Plan;
- (b) Establishing a circulation system designed to ensure pedestrian and bicycle safety over maximum vehicle traffic speeds;
- (c) Providing pedestrian, bicycle, and vehicle linkages to existing major transportation corridors (*e.g.*, SR-14, I-5), shopping destinations, and rail/transit within the City; and
- (d) Encouraging the use of public transportation by providing a multi-modal transit hub, which will add to the range of rail/transit services available in this portion of the City.

3.8.2.2 Local and Regional Vehicular Circulation Design

The Specific Plan's vehicle circulation network includes a hierarchy of streets ranging from secondary highways to private neighborhood streets and drives. SR-14 and I-5 provide regional access to the Specific Plan site and beyond. Internally, circulation is established through the use of Lost Canyon Road as the central thoroughfare in PA-1 and PA-2, connecting to Vista Canyon Road at a centrally located roundabout. These streets intersect with other neighborhood streets and the "Main Street" thoroughfare (Vista Square), which, like the rest of the Specific Plan, is designed as a pedestrian-oriented environment by creating multiple points of access to and from residential areas.

In PA-3, Lost Canyon Road is down-sized and interconnected with the residential neighborhood streets. PA-3 also includes a loop trail system, which links the area to the other Planning Areas within the Specific Plan site. This inter-connected roadway design and network permits the dispersion of vehicle trips among the various internal streets, which allows the streets to be narrower while still meeting the City's traffic flow and emergency vehicle requirements.

3.9 TRANSPORTATION DEMAND MANAGEMENT

3.9.1 EXISTING CONDITIONS

Currently, there is no vehicular, bicycle, or pedestrian access to and from the Specific Plan site due to its largely undeveloped condition.

3.9.2 PROPOSED CONDITIONS

The Specific Plan is designed to promote the use of alternative local and regional modes of transportation in lieu of automobile use. Increasing the use of alternative forms of transportation helps to meet local and regional transportation planning objectives (such as improving traffic flow and minimizing vehicle trips), environmental objectives (such as improving air quality and minimizing GHG emissions), and social objectives (such as improving quality of life). The goals of the Specific Plan's Transportation Demand Management (TDM) program are to: (a) reduce the number of vehicles trips generated by future uses within the Specific Plan and its vicinity; (b) increase awareness and participation in the TDM program by encouraging development within the Specific Plan to implement TDM concepts; and (c) increase transit ridership and the use of alternative transportation modes within the Specific Plan and the City as a whole.

TDM Program Components. The Specific Plan's City/MetroLink transit hub within the Specific Plan site is envisioned as a place to conveniently access transit (rail/bus) in eastern Santa Clarita. Local and regional transportation alternatives will be provided within the transit center, and result in the extension of rail and bus service to and from the Specific Plan and its vicinity. Other components planned as part of the Specific Plan's final TDM Program would include, but not be limited to:

- (a) **Introductory Transportation Information Packet.** These packets will be provided to all residents, owners, and employees within the Specific Plan, and outline rail and bus routes, schedules, and available carpool/vanpool/shuttle services.
- (b) **Park-n-Ride.** Park-n-Ride parking will be provided within the transit hub in PA-2. There will be up to 750 designated park-n-ride spaces provided at Specific Plan buildout.

- (c) **Coordination.** The Specific Plan applicant is committed to the following TDM implementation strategies:
- (i) Work closely with the City, Metrolink, and others to develop a successful and thriving transit center and associated facilities and services;
 - (ii) Work closely with the transit providers in the City and County to assure that the routes, transit stop locations, information signage, and related facilities will meet the needs of the people who live, work, and shop within the Specific Plan and surrounding vicinity; and
 - (iii) Utilize similar standards of urban design and architectural quality for the transit center, stops, signage, shelters, and similar structures.

4.1 PURPOSE

This section provides regulations for the development and land uses within the Specific Plan, and describes how these development regulations will be used as part of the City's development review process. Proposed development, subdivisions, and new land uses within the Specific Plan area must comply with all applicable requirements of this Specific Plan.

4.2 CONSISTENCY WITH ADOPTED PLANS

As required by Government Code sections 65454 and 65455, upon adoption, the Specific Plan would be consistent with the City's adopted General Plan. **Appendix 1.0-2** of this Specific Plan discusses this consistency in detail.

All subsequent land use entitlements and permits (*e.g.*, tentative tract maps, parcel map, zone change, Conditional Use Permit) implementing the Specific Plan also must be consistent with the Specific Plan.

4.3 RELATIONSHIP TO CITY'S UNIFIED DEVELOPMENT CODE

The Specific Plan, including the development regulations, are intended to provide a comprehensive set of regulations governing the use and development of the land within the Specific Plan area. These Development Regulations replace the requirements of the City's Unified Development Code, Titles 16 and 17 of the Santa Clarita Municipal Code. Any matter or issue not specifically and directly covered by this Specific Plan shall be subject to the non-conflicting regulations and procedures of the SCMC. If a conflict arises between the Specific Plan and the City's Unified Development Code, the provisions of this Specific Plan shall control.

4.4 EXISTING USES AND SEVERABILITY

Existing uses within the Specific Plan area as of the effective date of this Specific Plan are addressed as follows:

- (a) Any development or land uses that were lawfully established and existing as of the effective date of this Specific Plan may continue, and may be altered or replaced, only in compliance with this Specific Plan; and
- (b) Existing land uses that may continue within the Specific Plan area include water supply well operations and maintenance; maintenance and operation of all existing easements and pipelines; and Mitchell Hill cemetery.

If any term or provision of this Specific Plan, or the application of any provision of this Specific Plan to a particular situation, shall for any reason be found to be invalid or unenforceable by a

court of confident jurisdiction, such term or provision will remain in force and effect to the extent allowed by such ruling, and all other terms and other provisions of this Specific Plan or its application shall remain in full force and effect.

4.5 ADMINISTRATION

The regulations, standards, and other requirements of this Specific Plan shall be administered and enforced by the City's Community Development Department, Planning Commission, and City Council in the same manner as the provisions of the City's Unified Development Code.

4.6 LAND USE DESIGNATIONS

4.6.1 LAND USE PLAN AND ZONES

The following land use designation zones are established by this Specific Plan, and are applied to the property within the Specific Plan area as shown on the Land Use Plan (**Figure 2.0-1**):

1. **Residential (R).** The R land use designation zone is applied to areas appropriate for a variety of attached and detached residential units, including condominiums, apartments, residential flats, attached residential with surface parking, and attached residential with parking structure. The R designation includes for rent and for sale units. The designation also allows recreation, trails, landscaped areas, and parking areas to support the residential areas.
2. **Mixed-Use (MU).** The MU land use designation zone is applied to areas appropriate for a wide-range of land uses, and allows multi-family residential, office, retail, and general commercial uses, and office over retail, hotel/lodging, theatre, cinema or performing arts, studios, health/fitness facilities, churches, child care facilities, community assembly, and outdoor dining. Civic uses also are encouraged in this zone. Street frontages in the MU zone are pedestrian-oriented, and parking structures, surface parking and subterranean parking are allowed. Further, this zone contemplates a variety of office uses, including areas appropriate for business, financial, professional, business support service, processing, administrative, bank, medical services, and other office and supporting uses. This zone will accommodate local and regional employment needs and enhance the Specific Plan's housing/employment balance objectives. This zone also contemplates a variety of retail uses, including areas appropriate for restaurant, café, coffee shop (including outdoor seating), market, general retail, food service (including drive-through facilities), and entertainment.
3. **Open Space (OS).** The OS land use designation zone is applied to the Santa Clara River Corridor and the Mitchell Hill Open Space, including buried bank stabilization areas and the Santa Clara River Trail.
4. **Other (O).** The O land use designation zone is applied to areas containing public facilities, streets, and recreation areas. Areas covered by the O designation include the

water reclamation plant, Oak Park, public streets, Metrolink Station, Bus Transfer Station, Community Garden, Town Green, and pocket parks.

4.7 SITE DEVELOPMENT STANDARDS

This section sets forth the Development Standards governing each of the land use designation zones shown on the Land Use Plan (**Figure 2.0-1**), and described in **Section 4.6**, above. The Specific Plan's Development Standards are set forth in the Site Development Standards Matrix (**Tables 4.0-1a** and **4.0-1b**). The Site Development Standards Matrix provides the standards for minimum lot area; maximum site coverage; front, side, and rear yard setbacks, and maximum non-residential building heights, as appropriate to each land use designation zone.

**Table 4.0-1a
Site Development Standards Matrix(PA-1 and PA-2)**

Site Development Standards			
Land Use Designation	Minimum Lot Area (Sq.Ft.)	Minimum Building Setbacks From Streets (1)	Maximum Building Heights
PA-1			
Residential			
Multi-Family	5,000	0 ft.	50 ft. ²
Other	2,000	5 ft.	30 ft. ²
PA-2			
Mixed Use			
Mixed Use	5,000	0 ft.	55 ft. ²
Commercial	5,000	0 ft.	55 ft. ²
Office (two buildings adjacent to the Lost Canyon Road/Vista Canyon intersection)	5,000	5 ft.	95 ft. ²
Office (south of the two office buildings at the intersection of Lost Canyon Road/Vista Canyon Road)	5,000	5 ft.	60 ft. ²
Residential	5,000	0 ft.	50 ft. ²
Other	2,000	0 ft.	30 ft. ²

Notes:

- (1) Streets include "A" Drive, "B" Drive, "C" Drive and Vista Square Drive. A minimum building setback of 5 ft. shall be maintained along Lost Canyon Road (Planning Areas 1 and 2) and Vista Canyon Road (Planning Area 2). Setback shall be measured from the end of the sidewalk to the structure.
- (2) Maximum building height excludes architectural elements. Architectural elements are allowed to exceed designated height limit by 20 percent.

**Table 4.0-1b
Site Development Standards (PA-3)**

Site Development Standards						
Land Use Designation	Minimum Lot Area (Sq.Ft.)	Required Setbacks				Maximum Building Heights
		Front (Main Structure)	Side Street (Each Side)	Side Yard (Each Side)	Rear	
PA-3						
Residential ¹						
Single-Family	3,500	10 ft.	5 ft.	5 ft.	10 ft.	35 ft.
Multi-Family (including detached condos)	5,000	5 ft.	5 ft.	5 ft.	Not Required	35 ft.
Other	2,000	5 ft.	Not Required	Not Required	5 ft.	35 ft.

Notes:

(1) Driveways for front-loaded detached condos shall be 2 ft. from street or drive to garage. Alley-loaded garages shall have a minimum building setback of 2 ft. from garage to alley. All driveways on single-family homes (not including alley-loaded homes) shall be a minimum of 18 ft. in length as measured from the back of the sidewalk to the garage.

(2) Maximum building height excludes architectural elements. Architectural elements are allowed to exceed designated height limit by 20 percent.

4.8 ALLOWED LAND USES/PERMIT REQUIREMENTS

4.8.1 INTRODUCTION

This section sets forth the allowed land uses (*i.e.*, permitted uses) and permit requirements within each of the land use designation zones described in **Section 4.6**, and as shown on the Land Use Plan (**Figure 2.0-1**). **Table 4.0-2** identifies the allowed land uses and permit requirements within each land use designation zone within the Specific Plan area. Each Land Use Type shown on **Table 4.0-2** is defined in Unified Development Code, Chapter 17.12 (Use Type Classifications). These definitions shall be applied within the Specific Plan area.

Any one or more land uses identified by **Table 4.0-2** as allowed land uses within a specific land use designation zone may be established on any parcel within that zone, subject only to the planning permit requirements, if any, listed in the table.

A land use type that is not listed in **Table 4.0-2** is not allowed within the Specific Plan area, except as otherwise provided in the paragraph below. A land use that is listed in **Table 4.0-2**, but not within a particular land use designation zone, is not allowed within that zone.

The City's Director of the Community Development Department may determine that a proposed land use type not listed in **Table 4.0-2** is an allowed land use through the process described in Chapter 17.13 (Permitted Use Charts) of the SCMC.

Temporary uses are allowed within the Specific Plan area in compliance with the Temporary Use Permit requirements of the SCMC.

4.8.2 PERMIT REQUIREMENTS

Table 4.0-2 provides for land uses that are:

1. Permitted uses associated with initial building construction within the Specific Plan area, subject to Development Review. These uses are shown as "P" uses in the table.
2. Permitted uses within existing buildings within the Specific Plan area, subject to compliance with all applicable provisions of this Specific Plan. These uses are shown as "P" uses in the table.
3. Allowed subject to approval of a Minor Use Permit, and shown as "MUP" in the table.
4. Allowed subject to approval of a Conditional Use Permit, and shown as "CUP" in the table.
5. Not allowed in particular zones, and shown as an "X" in the table.

In **Table 4.0-2**, the last column ("Additional Regulations") may include a section number. The section number refers to a regulation in the referenced section of this Specific Plan or the SCMC that applies to the specified land use.

Uses not specifically listed in **Table 4.0-2** shall be regulated consistent with permitted uses in the Residential Medium (RM), Commercial Town Center (CTC), and Community Commercial (CC) zones described for each zoning designation in Chapter 17.13 (Permitted Use Charts) of the SCMC as follows:

- 1) PA 1 and PA 3 – Residential Medium (RM) Zoning Designation
- 2) PA 2 – Commercial Town Center (CTC) Zoning Designation

**Table 4.0-2
Allowed Land Uses and Permit Requirements**

Legend							
P	Permitted Use, Development Review required	CUP	Conditional Use Permit request required				
MUP	Permitted subject to Minor Use Permit	X	Use not allowed				
Legend for Zone Symbols							
PA-1	Planning Area 1	PA-2	Planning Area 2	O	Other		
PA-3	Planning Area 3	OS	Open Space				
LAND USE TYPE ¹	Permit Required by Zone						Additional Regulations
	PA-1	PA-2	PA-3		O	OS	
AGRICULTURAL USES							
Animal keeping - Small animals	P	P	P		X	X	17.17.020
Plant nursery	X	X	X		X	X	
INDUSTRY, MANUFACTURING & PROCESSING WHOLESALE USES							
Artisan/craft product manufacturing	X	P	X		X	X	
Construction contractor	X	X	X		X	X	
Furniture and fixtures manufacturing, cabinet shop	X	X	X		X	X	
Laboratory - Medical, analytical	X	P ²	X		X	X	
Manufacturing/processing - Heavy	X	X	X		X	X	
Manufacturing/processing - Light	X	X	X		X	X	
Media production - Office or storefront type	X	P ²	X		X	X	
Media production - Soundstage type	X	P ²	X		X	X	
Printing and publishing	X	P	X		X	X	
Research and development	X	P	X		X	X	
Storage - Indoor	X	P	X		X	X	
Storage - Outdoor, maximum stacking height of 10.8	X	X	X		P ³	X	
RECREATION EDUCATION & PUBLIC ASSEMBLY USES							
Adult business	X	P ⁴	X		X	X	17.17.050
Commercial recreation facility - Indoor	X	P	X		X	X	
Community assembly (church, etc.)	X	P	X		X	X	
Health/fitness facility	X	P	X		X	X	
Library, museum	X	P	X		X	X	
Live entertainment	X	MUP	X		X	X	
School, public or private	X	P	X		X	X	
Studio - Art, dance, martial arts, music, etc.	X	P	X		X	X	
Theatre cinema or performing arts	X	P	X		X	X	
RESIDENTIAL USES							
Boarding house	P	P	P		X	X	
Caretaker residence	P	P	P		X	X	
Dwelling - Multi-family	P	P	P		X	X	
Dwelling - Single-family	X	X	P		X	X	

**Table 4.0-2
Allowed Land Uses and Permit Requirements**

Legend							
P	Permitted Use, Development Review required	CUP	Conditional Use Permit request required				
MUP	Permitted subject to Minor Use Permit	X	Use not allowed				
Legend for Zone Symbols							
PA-1	Planning Area 1	PA-2	Planning Area 2	O	Other		
PA-3	Planning Area 3	OS	Open Space				
LAND USE TYPE ¹	Permit Required by Zone						Additional Regulations
	PA-1	PA-2	PA-3		O	OS	
Home occupation	P	P	P		X	X	17.03.090
Joint living/working quarters ⁵	P ⁵	P	P ⁵		X	X	17.17.040
Model Homes, Rental, Sales Offices	P	P	P		X	X	
Residential accessory use or structure	P	P	P		X	X	
Residential health care facility	X	P	X		X	X	
Residential service/area home	P	P	P		X	X	
Second unit/carriage house	X	X	P		X	X	
RETAIL USES							
Antique or collectible store (second hand store)	X	P	X		X	X	
Auto or motor vehicle rental	X	P	X		X	X	
Bar, tavern, night club, wine bars, cigar/hookah club (including the sale of alcoholic beverages)	X	MUP	X		X	X	
Bicycle Sales and Rental	X	P	X		X	X	
Building and landscape materials sales(no outdoor storage)	X	X	X		X	X	
Furniture, appliance, and equipment store	X	P	X		X	X	
General retail, except with any of the following features	X	P	X		X	X	
Alcoholic beverage sales	X	P	X		X	X	
Auto - or motor-vehicle related sales or services	X	X	X		X	X	
Drive-through facilities	X	P	X		X	X	
Floor area over 20,000 sf	X	P	X		X	X	
On-site production of items sold	X	P	X		X	X	
Operating between 11:00 pm and 7:00 AM	X	P	X		X	X	
Used merchandise	X	P	X		X	X	
Neighborhood market/convenience store (including accessory alcohol sales)	X	P	X		X	X	
Outdoor display and sales	X	P	X		X	X	
Restaurant, café, coffee shop (including alcohol sales), except drive-through	X	P	MUP*		X	X	

**Table 4.0-2
Allowed Land Uses and Permit Requirements**

Legend							
P	Permitted Use, Development Review required	CUP	Conditional Use Permit request required				
MUP	Permitted subject to Minor Use Permit	X	Use not allowed				
Legend for Zone Symbols							
PA-1	Planning Area 1	PA-2	Planning Area 2	O	Other		
PA-3	Planning Area 3	OS	Open Space				
LAND USE TYPE ¹	Permit Required by Zone						Additional Regulations
	PA-1	PA-2	PA-3		O	OS	

SERVICES - BUSINESS, FINANCIAL, PROFESSIONAL

ATM	X	P	X		X	X	
Bank, financial services	X	P	X		X	X	
Business support service	X	P	X		X	X	
Medical services - Clinic, urgent care	X	P	X		X	X	
Medical services - Doctor office	X	P ²	X		X	X	
Medical services - Extended care	X	P	X		X	X	
Office - Business, service	X	P	X		X	X	
Office - Professional, administrative, processing	X	P ²	X		X	X	

SERVICES - GENERAL

Animal sales and services (daycare, grooming, pet stores)	X	P	X		X	X	
Auction Facility	X	P	X		X	X	
Catering service	X	P ²	X		X	X	
Child day care - Large or small family day care home	X	P	X		X	X	
Day care center - Child or adult	X	P	X		X	X	
Drive-through service	X	P	X		X	X	
Equipment rental, indoor only	X	X	X		X	X	
Lodging - Bed & breakfast inn (B&B)	X	P	P		X	X	
Lodging - Hotel or motel (including accessory on-site sale of alcohol)	X	P	X		X	X	
Maintenance service - Client site services	X	P	X		X	X	
Mortuary, funeral home	X	P	X		X	X	
Personal services	X	P	X		X	X	
Personal services – Restricted	X	P	X		X	X	
Public services, general	X	P	X		X	X	

**Table 4.0-2
Allowed Land Uses and Permit Requirements**

Legend							
P	Permitted Use, Development Review required	CUP	Conditional Use Permit request required				
MUP	Permitted subject to Minor Use Permit	X	Use not allowed				
Legend for Zone Symbols							
PA-1	Planning Area 1	PA-2	Planning Area 2	O	Other		
PA-3	Planning Area 3	OS	Open Space				
LAND USE TYPE ¹	Permit Required by Zone						Additional Regulations
	PA-1	PA-2	PA-3		O	OS	
TRANSPORTATION, COMMUNICATIONS, INFRASTRUCTURE							
Parking facility, public or commercial	P	P	P		P	X	
Wireless telecommunications facility, Less than 35 ft high	P	P	P		P	X	
Wireless telecommunications facility, 35 ft height or more	P	P	X		P	X	
Wireless telecommunications facility - Flush mounted on existing structure	P	P	X		P	P	
Wireless telecommunications facility - Co-located	P	P	P		P	P	
Transit station or terminal	X	P	X		P	X	
ACCESSORY USES							
Amphitheaters, small accessory to parks or recreation areas	X	P	P		P	X	
Animals, maintained as pets for personal use	P	P	P		X	X	
Athletic fields and facilities	X	X	P		P	X	
Christmas trees and wreath sales	P	P	P		X	X	
Circuses, temporary	X	P	X		P	X	
Greenhouses, non-commercial	X	X	P		P	X	
Golf course driving ranges	X	X	X		X	X	
Heliports	X	MUP	X		X	X	
Helistops	X	MUP	X		X	X	
Outdoor events/festivals, temporary	P ⁶	P ⁶	X		P ⁶	X	
Parking lots, accessory to principal use	P	P	P		P	X	
Parks, public and private	P	P	P		P	P	
Rental, leasing, and repair of article sold on premises	X	P	X		X	X	
Swimming facility	P	P	P		P	X	
Farmer's market	X	P	X		P	X	
Trails, biking	P	P	P		P	P	
Trails, equestrian	P	P	P		P	P	
Trails, pedestrian	P	P	P		P	P	

**Table 4.0-2
Allowed Land Uses and Permit Requirements**

Legend							
P	Permitted Use, Development Review required	CUP	Conditional Use Permit request required				
MUP	Permitted subject to Minor Use Permit	X	Use not allowed				
Legend for Zone Symbols							
PA-1	Planning Area 1	PA-2	Planning Area 2	O	Other		
PA-3	Planning Area 3	OS	Open Space				
LAND USE TYPE ¹	Permit Required by Zone						Additional Regulations
	PA-1	PA-2	PA-3		O	OS	

Notes:

- (1) A definition of each listed use type is in Unified Development Code Chapter 17.12 (Use Type Classifications).
- (2) Use allowed only on second or upper floor, or behind ground floor use on mixed-use buildings (i.e., retail/office).
- (3) Outdoor storage permitted in Metrolink/transit station area.
- (4) Requires Adult Business Permit in compliance with Unified Development Code Section 17.17.050.
- (5) In live/work areas, retail uses and general, business, financial and professional services are permitted.
- (6) Subject to a Temporary Use Permit consistent with Section 17.03.080 of the Unified Development Code.
- (*) Subject to approval of a minor use permit; only permitted as an accessory use to the private recreational facility in PA-3

4.9 TRANSFER/CONVERSION/ADJUSTMENT REGULATIONS

4.9.1 PURPOSE AND INTENT

This section sets forth the regulations governing Planning Area boundary and acreage adjustments and conversions from one land use designation zone to another, which are permitted by the Specific Plan. These regulations are intended to provide land use flexibility in the implementation of the Specific Plan. Flexibility is needed because of the size of the Specific Plan area, and the time required to complete buildout of the Specific Plan land uses. The intent of these measures is to ensure that each development phase can respond to the then current market, economic, and social changes in demand.

4.9.2 PA-2 AND PA-3 TRANSFERS

To provide flexibility, the Specific Plan permits the transfer of up to 81 of the 325 residential units within PA-2 to PA-3. Conversely, up to 74 of the 295 residential units in PA-3 can be transferred to PA-2. However, in no case shall the project exceed a total of 1,100 residential units.

4.9.3 PLANNING AREA BOUNDARY, ACREAGE AND ADJUSTMENTS

Precise Planning Area boundaries and acreages shall be established at the subdivision map recordation phase. A subdivision map, or phased map, submittal may incorporate an adjustment in the gross acreage of each Planning Area, as shown on the Land Use Plan Statistical Summary (**Table 2.0-2**), without necessitating a Specific Plan amendment or a Development Review, provided that each Planning Area affected by the boundary or acreage adjustment still retains a minimum of 80 percent of the original total gross acreage and does not exceed 120 percent of the original gross acreage approved under the Specific Plan.

The City and the applicant (or its designee) will retain certain flexibility with respect to the details of the Specific Plan and, therefore, agree that the following Administrative Modifications for each Planning Area shall, unless otherwise provided in the Specific Plan, be approved by the Director of Community Development:

- (a) In order to accommodate the needs of third party purchasers, the size and configuration of lots or parcels and dimensions and/or locations of improvements may be modified at the discretion of the applicant, and the City shall fully cooperate therewith, subject to the provisions of the Subdivision Map Act, and provided that the aggregate total density and intensity of the particular Planning Area are not increased, the permitted uses are not modified from those approved, and the parcels and lots and improvements thereon are consistent with the applicable rules and project approvals, including all development standards contained within this Specific Plan.
- (b) The design and configuration of lots and related improvements within the Specific Plan site may be reconfigured and redesigned by the applicant provided the number of residential units or commercial square footage is not increased. Such reconfiguration and redesign may include making one or more Planning Areas less dense, converting one or more lots from air space condominium purposes to individual fee lots, and modifying the design of streets, curbs, gutters, sidewalks, drainage and affected utilities to be consistent with such reconfiguration and redesign so long as each reconfiguration and redesign is otherwise consistent with the design and configuration standards and requirements in the Specific Plan and Conditions of Approval.
- (c) Any subsequent revision to the tentative tract map that is submitted for review and approval shall be approved by the City provided the residential and commercial lot design and configuration complies with the Specific Plan and Conditions of Approval.
- (d) Upon adoption of the Specific Plan, the applicant shall have the vested right to develop the Specific Plan site that is consistent with the project approvals and the Specific Plan. The City agrees to process and administratively approve any modifications to the tentative tract map, including modifications in the size, design and configuration of the lots and improvements as provided in the Specific Plan and Conditions of Approval,

required for the applicant to develop the Specific Plan site consistent with the Specific Plan and project approvals, and such administrative approvals are deemed to constitute ministerial acts implementing the Specific Plan and the project approvals.

4.10 SIGNAGE REGULATIONS

4.10.1 PURPOSE AND INTENT

The signage regulations in this section shall govern the design and maintenance of all signage within the Specific Plan area. The regulations are intended to result in functional, attractive signage that incorporates a uniformly high level of design, graphics, continuity, consistency, and maintenance throughout the Specific Plan area. All signage is intended to be consistent with the architectural and landscape character of the specific parcel development and with the design intent of the Specific Plan as a whole. Consistency shall be determined in terms of materials, scale, size, and placement on buildings or in landscaping; integration with the buildings' architectural design, texture, color, relation to other signage in the immediate vicinity and in the public spaces; and type of illumination, if any. The scale and proportion of graphics used in signage shall be consonance with the design of buildings, individual stores, landscape, and site design. Bold or inharmonious colors or color combinations shall not be used.

The purposes of the signage regulations are to:

- (a) Avoid traffic safety hazards to motorists, bicyclists, and pedestrians caused by visual distractions and obstructions;
- (b) Promote the aesthetic values of the Specific Plan community by providing for signs that do not impair its attractiveness as a place to live, work, play, and shop;
- (c) Provide for signs as an effective channel of communication while ensuring that signs are aesthetically proportioned in relation to adjacent buildings/structures and the buildings/structures to which they are attached; and
- (d) Safeguard and protect the public health, safety, and general welfare.

4.10.2 APPLICABILITY AND CONFORMANCE

Consistent with the intent and purpose provisions set forth above, all signage within the Specific Plan area shall conform to the requirements of the SCMC provisions regulating signage on private property (Chapter 17.19, sections 17.19.010 through 17.19.280). Additionally, the project applicant shall be permitted to install one freeway-commercial center sign, consistent with the requirements included in Chapter 17.19,.190.I on the Mitchell Hill Open Space Area. The City will provide the applicant with a permanent easement for the placement and maintenance of a sign upon the transfer of ownership of Mitchell Hill to the City. The freeway-

commercial center sign shall be subject to an administrative sign plan review or can be included in a comprehensive sign program for the Vista Canyon development.

No person shall erect, construct, enlarge, alter, move, improve, remove, convert, or equip any sign or sign structure, or cause or permit the same to be done, contrary to or in violation of the provisions of this Specific Plan and the SCMC (Chapter 17.19). Conformance shall be strictly enforced. All non-conforming or unapproved signs shall be brought into conformance at the expense of the person(s) responsible for installation of the sign or sign structures.

4.11 PARKING REGULATIONS

4.11.1 PURPOSE AND INTENT

Parking regulations within the Specific Plan are intended to utilize a combination of shared and non-shared parking to provide the requisite number of parking spaces for all uses, while reinforcing the Specific Plan's mixed-use and pedestrian oriented character. This intent can be accomplished by minimizing vehicle trips and parking demand, and providing a mix of uses within walking distance of each other and within walking distance of transit services. The overall purpose, therefore, of the Specific Plan's Parking Regulations is to create a well-planned mixed-use community that reduces the areas required for parking and roadways, which in turn promotes the live, work, play, and shop atmosphere envisioned by the Specific Plan.

4.11.2 PARKING REGULATIONS

The Specific Plan establishes shared and non-shared parking requirements in PA-1 and PA-2. PA-3 would comply with the SCMC parking standards (see SCMC, Chap. 17.18 Parking Standards, §§17.18.010-17.18.150, as amended). The Specific Plan's Parking Regulations governing PA-1 and PA-2 are as follows:

- (a) **Residential Use Parking Within PA-1 and PA-2.** The residential parking supply within PA-1 and PA-2 require a total of 1,277 parking spaces, based on the ULI Shared Parking recommended parking ratios of 1.5 spaces per unit for rental units, and 1.7 spaces per unit for ownership units, none of which would be shared parking. Residential guest parking is not included in this total (1,277 spaces), but is included below in the non-residential shared parking calculations. However, because the Specific Plan would be developed in phases over time, residential uses in PA-1 and PA-2 will be required initially to have parking at a number equal to the SCMC parking standards, as amended, until such time as the Metrolink Station is constructed and operational and a minimum of 50,000 square feet of non-residential floor area is constructed. Interim parking spaces in excess of such requirements will be contained within temporary surface parking lots.
- (b) **Non-Residential Uses and Guest Parking.** The non-residential and residential guest parking required for the Specific Plan is 2,939 spaces under a shared parking program.

This supply includes peak weekday parking demand of 2,721 spaces for PA-1 and PA-2, plus an 8 percent parking vacancy factor, which adds 218 parking spaces, resulting in a required parking supply of 2,939 spaces. Parking management is an essential element of a successful shared parking program. The Specific Plan requires shared parking management practices and reciprocal parking easements over the parking spaces within the shared parking pool in PA-1 and PA-2.

- (c) **Parking Space Specifications.** Unless otherwise noted in the Specific Plan, all required parking spaces shall be designed in accordance with the specifications set forth in section 17.18.070 of the SCMC, as amended.
- (d) **PA-3 Parking.** The parking supply for PA-3 is self-contained and not part of the Specific Plan's shared parking pool. Parking for PA-3 would comply with SCMC parking standards, as amended.

4.11.3 PARKING REQUIREMENTS

Because the exact specifications and uses within PA-1 and PA-2 may slightly change as each planning area is developed in phases, the Specific Plan includes the following requirements:

- (a) Parking requirements within PA-1 and PA-2 will be calculated using the Vista Canyon/ULI Shared Parking model included in the *Parking Demand Analysis*, prepared by Richard Willson, Ph.D., FAICP, dated April 2010 (*Parking Demand Analysis* (April 2010); **Appendix 2.0-1**).
- (b) The parking requirements for PA-1 and PA-2 may be adjusted by the applicant or its designee and the City based on new information related to changes in user characteristics, daily parking patterns, and intensity of use. Such changes must be based on documented field studies, experience with other similar projects, or other relevant data, but will rely on the Vista Canyon ULI Shared Parking model. Any substantial changes to the parking requirements for PA-1 and PA-2 by the project applicant are subject to the review and approval of the Director of Community Development through an Adjustment Permit process. Changes that are not substantial shall be approved by a Development Review Permit. All property owners' associations within the applicable Planning Area shall be notified of the changes prior to submitting to the City.
- (c) Specific uses, square footage, parking locations, and number of parking spaces as shown on Tentative Tract Map No. 69164 for PA-1 and PA-2 may be revised consistent with the requirements of the Specific Plan.
- (d) On-street parking within PA-1 and PA-2 is part of the Specific Plan's shared parking pool.

- (e) Selective gating, card operated entry points, chaining, limited duration parking zones or other parking control techniques may be utilized within PA-1 and PA-2 to the extent that they do not negatively impact the function and effectiveness of the Vista Canyon Shared Parking Program. See Appendix F (Protecting Parking Capacity for Other Users) to the Specific Plan's *Parking Demand Analysis* (**Appendix 2.0-1**) for information on these techniques.
- (f) Required parking for any residential use within PA-1 and PA-2 of the project is not included within the shared parking pool.
- (g) Pursuant to the Vista Canyon Specific Plan, the project would be developed in phases. Residential uses within PA-1 and PA-2 shall be parked at a number equal to the SCMC parking standards (SCMC, Chap. 17.18), as amended, until such time that the Metrolink Station is constructed and operational and a minimum of 50,000 square feet of non-residential floor area is constructed. This will require the construction of interim, surface parking spaces within PA-1 and PA-2 to supplement structured parking. The specific details of this interim parking plan will be included in an updated "Parking Demand Analysis" prepared for each incremental phase of development within PA-1 and PA-2.
- (h) An updated Parking Demand Analysis shall be performed for each incremental phase of development within PA-1 and PA-2 prior to construction. Shared parking demand, interim parking, and available parking spaces must be calculated for each phase of development, and the required number of parking spaces must be provided to meet the calculated parking demand.
- (i) The project applicant must record reciprocal parking easements over the parking spaces within the shared parking pool in PA-1 and PA-2. Additionally, the Covenants, Conditions, and Restrictions (CC&Rs) prepared for PA-1 and PA-2 must reference and incorporate the Specific Plan's parking requirements, including any approved, updated parking demand analyses.

5.1 PURPOSE AND INTENT

The purpose of the Specific Plan's Design Guidelines is to describe the visual character that is desired for development within Vista Canyon, and the manner in which developed areas should relate to other land use designation zones within the Specific Plan. The Design Guidelines address issues that are primarily aesthetic in nature and subject to a variety of solutions. Due to varying interpretations of aesthetic design, flexibility should be permitted to encourage design innovations and changes in design standards that occur over time. For these reasons, rigid adherence to the Specific Plan's Design Guidelines is not intended. Instead, it is intended that developments within Vista Canyon be evaluated for their substantial conformance to the general intent associated with the applicable "General Guidelines" and the other applicable guidelines set forth below.

5.2 GENERAL GUIDELINES

The following General Guidelines are intended to allow flexibility and innovation throughout the Specific Plan site.

5.2.1 DESIGN THEMES

- (a) Consistent with the *Santa Clarita Community Character and Design Guidelines* adopted by the City of Santa Clarita on March 24, 2009, Vista Canyon will retain and encourage architectural variety and promote quality development. The overarching design objectives are to create a sense of timelessness, ownership, place and identity, and community.
- (b) Neighborhood design concepts will encourage sustainable planning and design practices, including the smart growth, new urbanism, and sustainability principles described in Chapter 2 of the 2009 *Santa Clarita Community Character and Design Guidelines*.
- (c) Consideration should be given to strengthening the identity of each Planning Area through the use of landscape palettes, buildings, signage, and such other elements.
- (d) Siting and design of structures should consider views relative to the Specific Plan area.

5.2.2 SITE PLANNING

5.2.2.1 Residential

- (a) Residential streets should be designed so that traffic to the highway system flows as directly as possible. Circuitous street patterns and very long residential streets should be avoided.
- (b) Multi-family homes should be located near active centers, hubs, parks/recreation facilities, and trails throughout the Specific Plan site.
- (c) Creative siting, design, and landscaping solutions should be used to blend structures into the site, to the extent possible.
- (d) Pedestrian and vehicular circulation should be designed to create a consistent community image.
- (e) Entries to residential areas should be visibly reinforced through techniques such as landscape treatments, monument signage, and/or pavement details.

5.2.2.2 Mixed-Use/Commercial/Retail/Public Facilities

- (a) Prominent buildings should be sited in key locations and easily accessible.
- (b) Service areas should be effectively screened.
- (c) Mixed-use land use areas should be planned and integrated to provide functional and cohesive relationships.
- (d) Within the Mixed-Use land use designation, commercial, retail, and office buildings should be clustered around central gathering places.
- (e) Within the Mixed-Use land use designation, the shared use of service areas, parking, access, *etc.*, should be integrated into the overall design.

5.2.3 ARCHITECTURE

5.2.3.1 Residential

- (a) A diversity of architectural styles is encouraged to enhance the character of the community.
- (b) Use of roof overhangs, low-energy outdoor lighting, and passive solar systems to enhance energy conservation is encouraged.

- (c) Roof equipment should be screened from view where feasible.
- (d) Utility and service areas should be treated (*i.e.*, color, landscaping, screening) to minimize visual effects.
- (e) Variations in height within and among buildings is encouraged to create visual interest and avoid a monotonous street scene.
- (f) Siting variations in building facades, articulation, height, mass, and scale is encouraged to create and enhance architectural interest.
- (g) Elements such as stairways should be architecturally compatible and integrated into buildings.

5.2.3.2 Mixed-Use/Commercial/Retail/Public Facilities

- (a) Design of public facilities should be compatible with the surrounding areas.
- (b) Overhangs, trellises, and other architectural elements should be incorporated into the design of mixed-use/commercial/retail buildings where feasible.
- (c) Signage and lighting should be included as an integral element of buildings.
- (d) Architectural detailing should be used in Mixed-Use land use designations to assist in creating a design scene.
- (e) The use of roof overhangs, low-energy outdoor lighting, and passive solar systems to enhance energy conservation is encouraged.
- (f) Multi-level buildings should relate to the pedestrian. Ground-story front facades should be designed to strengthen pedestrian scale. Pedestrian scale along streets also should be established through the use of awnings or structural features, which add horizontal articulation to facades.
- (g) Roof equipment should be screened from view where feasible.
- (h) Utility and service areas should be treated (*i.e.*, color, landscaping, screening) to minimize visual effects.
- (i) Variations in height within and among buildings is encouraged to create visual interest and avoid a monotonous street scene.
- (j) Siting variations in building facades, articulation, height, mass, and scale is encouraged to create and enhance architectural interest.

- (k) Elements such as stairways should be architecturally compatible and integrated into buildings.

5.2.4 FENCING

- (a) Fencing should be compatible with the architectural theme and character of the neighborhood or specific development within a particular area.
- (b) Fencing should be consistent in style and color.
- (c) Wall or fencing sections should be horizontally offset at regular intervals to provide visual relief and landscape opportunities.
- (d) Fencing and landscaping should be designed as an integral part of the overall site design.

5.3 OTHER APPLICABLE ARCHITECTURAL GUIDELINES

The Specific Plan also incorporates by reference the applicable 2009 *Santa Clarita Community Character and Design Guidelines*. The City's 2009 *Community Character and Design Guidelines* received an Excellence Award for Best Practices from the American Planning Association (APA).

Specific to Vista Canyon, the desired architectural style will be "Rustic Californian." Based on the 2009 *Community Character and Design Guidelines*, this style represents a mix of the architectural elements found in Mission Revival, Arts and Crafts, Craftsmen, and Ranch styles. Commonly recognized elements authentic to each of these architectural styles will be utilized within Vista Canyon, including the introduction of natural materials such as stone veneer, exposed timbers, and selective accents. Conceptual renderings of the Vista Canyon Specific Plan, which illustrate this architectural style, are contained within **Appendix 5.0-1**.

The "Rustic Californian" architectural style incorporates numerous elements, including wall articulation, roof elements, attached elements, openings, accents, exterior building materials, and colors, all of which are described in Chapter 3 of the 2009 *Community Character and Design Guidelines*.

The comprehensive nature of the City's 2009 *Community Character and Design Guidelines* allows Vista Canyon to incorporate the community character and design elements associated with the Specific Plan's Residential (single-family and multi-family) and Mixed-Use land use designations. Specific to those land use designations, Chapter 4 (Single-Family Residential), Chapter 5 (Multi-Family Residential), Chapter 6 (Commercial), and Chapter 7 (Mixed-Use) of the 2009 *Community Character and Design Guidelines* will provide direction for new development within the Specific Plan.

Consistent with the 2009 *Community Character and Design Guidelines*, the Specific Plan's incorporation of these guidelines are intended to provide a general framework for design.

5.4 APPLICATION PROCESS

This Specific Plan will utilize the "Application Process" set forth in the 2009 *Community Character and Design Guidelines* (see Chapter 1), including the Development Review Committee process.

For all projects/developments within the Specific Plan, design review determinations shall be made by the City's Director of Community Development, and those determinations shall be considered the final decision.

6.1 PURPOSE AND INTENT

This section sets forth the Specific Plan's implementation procedures and phasing program.

The section contains procedures to implement the regulatory provisions of the Specific Plan, which are set forth in **Section 4.0, Development Regulations**. Included are provisions unique to the Specific Plan for the implementation of the Transfer/Conversion/Adjustment Regulations in **Section 4.0**.

The section also contains criteria under which the City's Director of Community Development may make a determination of whether a proposal is in substantial conformance with the Specific Plan; or whether, an amendment to the Specific Plan is required. In addition, the section provides a discussion of the California Government Code provisions governing the amendment of specific plans.

6.2 IMPLEMENTATION PROCEDURES AND PHASING

The Specific Plan will be implemented primarily through the process of subdivision maps. All land subdivision maps of any type (*e.g.*, tentative or final, vesting or non-vesting, tract or parcel) shall be submitted, reviewed, and approved in accordance with the SCMC and Subdivision Map Act. Where the provisions or procedures of the SCMC conflict with the provisions of this Specific Plan, the Specific Plan shall apply.

The Specific Plan will be completed in multiple phases in order to correlate infrastructure and amenities with site development, as set forth in the Specific Plan's Phasing Plan found in **Section 2.9**, above.

Subject to market and economic changes and conditions, the rate of growth in the immediate vicinity and region, and changes in infrastructure/public facilities requirements, conditions, and needs, the following phasing plan is assumed, with the initial phase being occupied in 2012 and the last phase being completed in 2015:

- (a) **Phase 1.** Phase 1 is anticipated to consist of construction of 480 residential units within PA-1, and 200 residential units and 25,000 square feet of retail within PA-2. Access will be provided by an extension of Lost Canyon Road from its present terminus in Fair Oaks Ranch to the property site, and an extension of Jakes Way. Construction of the water reclamation plant, all flood protection improvements, and the Santa Clara River trail also will be constructed in Phase 1. The entire site will be graded in conjunction with development of Phase 1. The property for the Bus Transfer Station and Oak Park will be offered for dedication to the City in conjunction with development of Phase 1.

- (b) **Phase 2.** Phase 2 is anticipated to consist of construction of 295 residential units and the Oak Park within PA-3, and 125 residential units and the Community Garden within PA-2. The Vista Canyon Road Bridge will be constructed and operational by the 150th occupancy within PA-3, and Lost Canyon Road will be extended to its easterly terminus near La Veda Avenue. Street improvements to the segment of Lost Canyon Road between the property site and Sand Canyon Road, and intersection improvements to Lost Canyon Road and Sand Canyon Road, will be completed prior to the opening of the connection of Lost Canyon Road to La Veda Avenue.
- (c) **Phase 3.** Phase 3 is anticipated to consist of construction of 50,000 square feet of commercial retail, 100,000 square feet of commercial office, and the initial phase of the Metrolink and Bus Transfer Stations and accessory parking within PA-2.
- (d) **Phase 4.** Phase 4 is anticipated to result in a completion of all remaining land uses within the project site (*e.g.*, commercial floor area and accessory parking within PA-2, and the Town Green).

6.3 IMPLEMENTATION OF TRANSFER/CONVERSION/ADJUSTMENT REGULATIONS

Regulations governing transfers, conversions, and adjustments are set forth in **Section 4.9** of the Specific Plan. To implement those regulations, the following expedited procedures shall be followed:

- (a) **Residential Development Transfer Option (PA-2/PA-3).** If the applicant or its designee seeks to implement the residential development transfer option between PA-2 and PA-3, the applicant or designee shall submit a Development Review to the City's Community Development Director to ensure that it is in substantial conformance with the Specific Plan.
- (b) **PA Boundary and/or Acreage Adjustment.** If the applicant or its designee seeks to adjust a Planning Area boundary or acreage, the applicant or designee shall incorporate the proposed adjustment in the appropriate subdivision map, or phased map. The adjustment shall not necessitate a Specific Plan amendment or a Development Review, provided that each Planning Area affected by the boundary or acreage adjustment still retains a minimum of 80 percent of the original total gross acreage and does not exceed 120 percent of the original gross acreage approved under the Specific Plan.
- (d) **Adjustments in Development Standards.** Consistent with the intent and purpose of the provisions set forth above, any modification within the Specific Plan site not permitted by the Specific Plan shall conform to the requirements of the SCMC provisions (Chapter 17.03, Section 17.03.050 – Variances and Adjustments).

6.4 SPECIFIC PLAN - SUBSTANTIAL CONSISTENCY

The City's Community Development Director is responsible for ensuring that construction activities and future uses are substantially consistent with the approved Specific Plan.

This includes deciding whether proposed developments or uses substantially comply with the conditions, permitted use chart, regulations, and guidelines of the Specific Plan and other applicable SCMC provisions that do not conflict with the Specific Plan including, but not limited to, the following:

- (a) Determinations regarding issues, conditions, or situations that arise and are not addressed by the Specific Plan.
- (b) Determinations as to whether a use not listed in the Allowed Land Uses and Permit Requirements table (**Table 4.0-2**) substantially complies with the land use designation in which the use is requested; and, therefore, is permitted within that land use designation.
- (c) Additions, deletions, or changes to the Specific Plan text, figures, tables, or appendices that substantially comply with the Specific Plan.
- (d) Adjustments to the plans contained in **Section 2.0**, Development Plan, provided that such adjustments do not change the requirement of providing adequate infrastructure and/or public facilities within the Specific Plan.

6.5 AMENDMENT PROCEDURES

The California Government Code (sections 65453-65454) sets forth the manner in which Specific Plans are to be prepared, adopted, and amended. Amendment(s) to the Specific Plan shall not require a concurrent General Plan amendment unless it is determined by the City's Director of the Community Development Department that the proposed Specific Plan amendment is inconsistent with the City's General Plan.