

Butterfield's Overland Mail Stage Stations in California from San Fernando Mission to Posey Creek

by
Gerald T. Ahnert

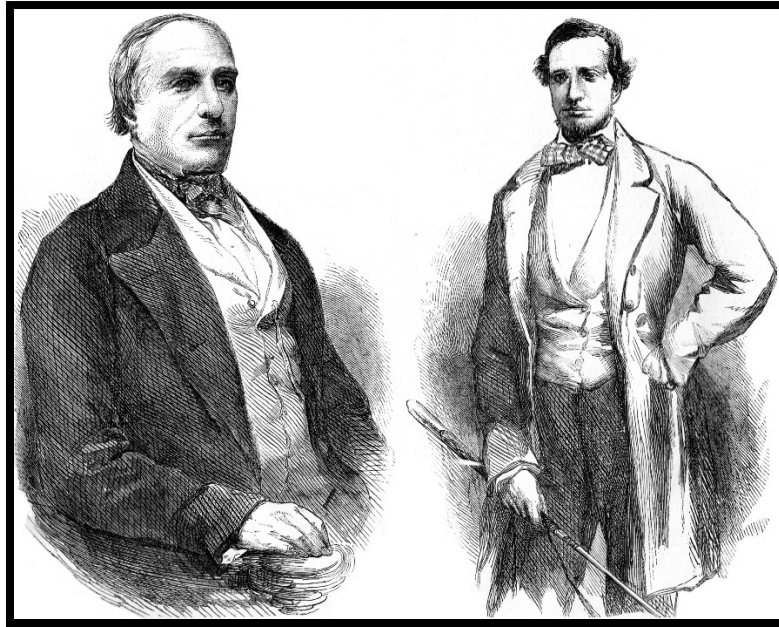

Figure 1. September 16, 1858, John Butterfield Sr. and John Jr. just before they boarded the first westbound Overland Mail Company Concord stagecoach in Tipton, Missouri.

John Jr. was the driver and John Sr. was the conductor.

From: *Frank Leslie's Illustrated Newspaper*, November 27, 1858.

The Butterfield Overland Mail by Roscoe P. and Margaret B. Conkling, published in 1947 by Arthur H. Clark Co., was based on their 1929-1933 trip along the trail. This monumental pioneering effort has provided a basis to build on for further research to locate the sites of the company's stage stations.

In the preface of their book, they state: "No documents in the archives in Washington, or in the libraries of New York or St. Louis, or matter from other published sources could give us the information we sought. Thus, it was that our efforts were spurred, and we determined to explore the route from end to end and collect ever available item of interest connected with it." Much of their information was collected from old-timers along the trail, and in the preface, they state, "we grew a little skeptical of the rural bards.... We were, however, far from satisfied with the results of this reconnaissance."

Our knowledge of this Old West enterprise has been expanded by Internet sites providing primary sources such as newspaper and university archives.

This report covers a 128-mile section, from the Overland Mail Company's San Fernando Mission Stage Station to its Posey Creek Stage Station, northeast of the present city of Bakersfield.

The Contract

The six-year Overland Mail Company Contract No. 12,578 was awarded September 16, 1857, to John Butterfield of Utica, New York. He had one year to build the infrastructure for the trail, with service to begin September 15, 1858, and to end September 15, 1864.¹

It was a stockholding company with 11 main stockholders who were also the directors. John Butterfield was president and the sole manager and organizer. William B. Dinsmore was the vice president, and John Butterfield's son-in-law Alexander Holland was treasurer. The Overland Mail Company was partly a Butterfield family affair as, besides John Butterfield's son-in-law as treasurer, John's son Charles was the senior superintendent stationed in Fayetteville, Arkansas, and his son John Jr. was a senior company assistant in Utica, New York. His son Daniel was employed as a clerk to record the route of the trail and station sites. It was said the document was so large that it would stretch across their office floor.

John Butterfield was the obvious choice for establishing a 2,700-mile-long stage line through the Western frontier from Tipton, Missouri, to San Francisco, California. By the time he was awarded the six-year mail contract, he had 38 years of staging experience and was operating 40 stage lines out of his hometown of Utica. He also had the necessary business contacts to help him raise the \$3.5 million² to finance the costly project. Newspapers in Washington, D.C., noted that no express companies bid on the contract since they had no staging experience.³

One of the most important stockholder-directors is listed as "M.L. Kinyon." His name was misspelled in the contract as "Marcus L. Kinyon." He was actually Marquis L. Kenyon from Rome, New York. Kenyon was the only other director besides Butterfield who had any staging experience.

The Architects of the Butterfield Trail: Marquis L. Kenyon and John Butterfield Jr.

John Butterfield sent his son John Jr. and company director Kenyon from New York to San Francisco. On January 16, 1858, they left San Francisco on mule back and traveled about 40 miles per day through the Southern Overland Corridor, selecting the route and stations sites. They completed the task by late April 1858.⁴

Very few stations had to be built from San Francisco to Los Angeles, as there existed a well-used trail with establishments that could be contracted for use as stage stations. The trail had been used since 1853 by the stage line of Phineas Banning.

From Los Angeles to Fort Smith, Arkansas, many new stations had to be built through the 1,920-mile-long frontier. The trail from Fort Smith to Tipton, Missouri, had been in use for many years, with some existing establishments that could be contracted for stations. The train from Tipton to St. Louis carried the mail 160 miles for the rest of the distance.

Postmaster General Aaron V. Brown appointed Goddard Bailey to take the first Butterfield stage from San Francisco to inspect the line. In his report, he listed the stations and

distances between them. Bailey reported: “This was compiled with great care, chiefly from data obtained on the road, and, although it doubtless contains some *errors*, it may be regarded as *approximately* correct.”⁵

Kenyon returned to California as superintendent of the First Division. Each division superintendent was assigned the task to contract for stations or to build new stations where they were needed. The *Los Angeles Star* of June 26, 1858, published an interview with Kenyon in which he gave a preliminary report of his station choices from San Francisco to Los Angeles. He stated that the distances between Fort Tejon and Los Angeles were measured with a “viameter,” more commonly known today as an odometer.

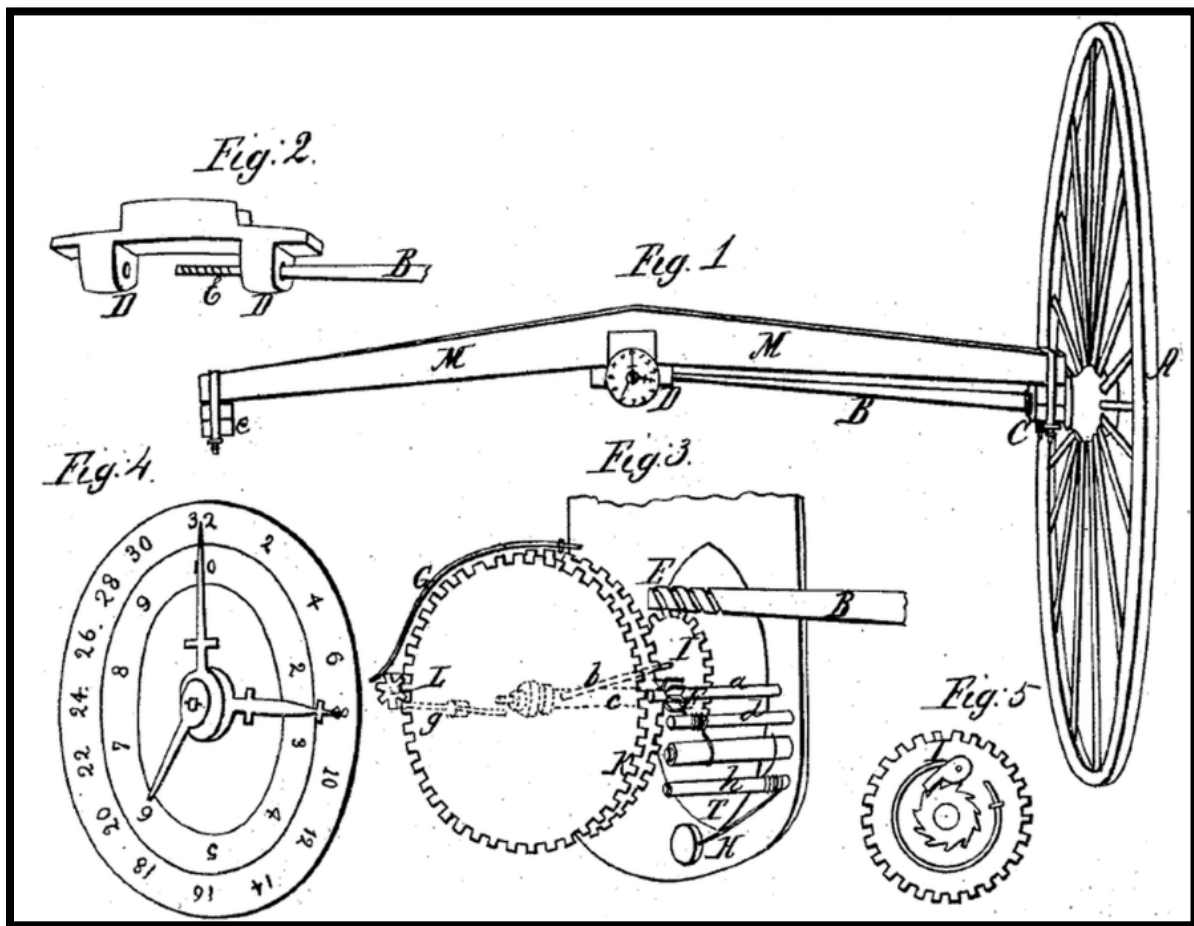

Figure 2. An 1839 patent for a wagon odometer similar to the “viameter” Kenyon used to measure distances between stations. The meter would show distances to 1/100 mile. In 1862, the California Column used them to measure the distances between many of the stations. I have found their data to be reasonably accurate and an important aid for identifying station locations.
Benjamin Franklin invented the wagon odometer.

Memorandum of distances between the stations on the overland mail route from San Francisco to St. Louis, and of the time made on the first trip.

FIRST DIVISION.

San Francisco to Clark's, 12 miles ; San Mateo, 9 ; Redwood City, 9 ; Mountain View, 12 ; San Jose, 11 ; Seventeen Mile House, 17 ; Gilroy, 13 ; Pacheco Pass, 18 ; St. Louis Ranch, 17 ; Lone Willow, 18 ; Temple's Ranch, 13 ; Firebaugh's Ferry, 12 ; Fresno City, 19 ; Elk Horn Spring, 22 ; Whitmore's Ferry, 17 ; Cross Creek, 12 ; Visalia, 12 ; Packwood, 12 ; Tule River, 14 ; Fountain Spring, 14 ; Mountain House, 12 ; Posey Creek, 15 ; Gordon's Ferry, 10 ; Kern River Slough, 12 ; Sink of Tejon, 14 ; Fort Tejon, 16 ; Reed's, 8 ; French John's, 14 ; Widow Smith's, 24 ; King's, 10 ; Hart's, 12 ; San Fernando Mission, 8 ; Cahuengo, 12 ; Los Angeles, 12. Total, 462 miles. Time, eighty hours.

Figure 3: These were the names of the stations given by Goddard Bailey at the beginning of Butterfield's Overland Mail Company service in September 1858 and are included in this report.

From: G. Bailey, Special Agent, to Hon. A. V. Brown, P. M. General, Washington, D.C., Appendix A, Great Overland Mail, Washington, October 18, 1858, The Senate of the United States, Second Session, Thirty-Fifth Congress, 1858-59, Washington, 1859.

Bailey estimated the distance between Fort Tejon and Los Angeles to be 100 miles. Kenyon's distance, measured with a viameter, was 93 miles, 493 yards.

After selecting the trail's route and station sites through the Southern Overland Corridor, Kenyon returned to California in June 1858 as Overland Mail Company superintendent for the First Division. The stage stations had to be stocked with horses, mules, harnesses, food, supplies and wagons, along with other equipment. Fifteen hundred employees were hired as station masters, superintendents and line riders to keep the trail in shape; as *vaqueros* (Mexican cowboys), to take care of the stock; and as stage conductors, stage drivers and blacksmiths. About 1,000 head of livestock were needed.⁶ Many of the stage drivers on the San Francisco-to-Los Angeles route were chosen from local, experienced stage drivers. One not from California was Kenyon's brother Tote from Rome, New York.⁷

The following four satellite images locate the nine Butterfield Overland Mail Company stage stations on the present topography of Southern California from the towns of San Fernando to just north of Bakersfield.

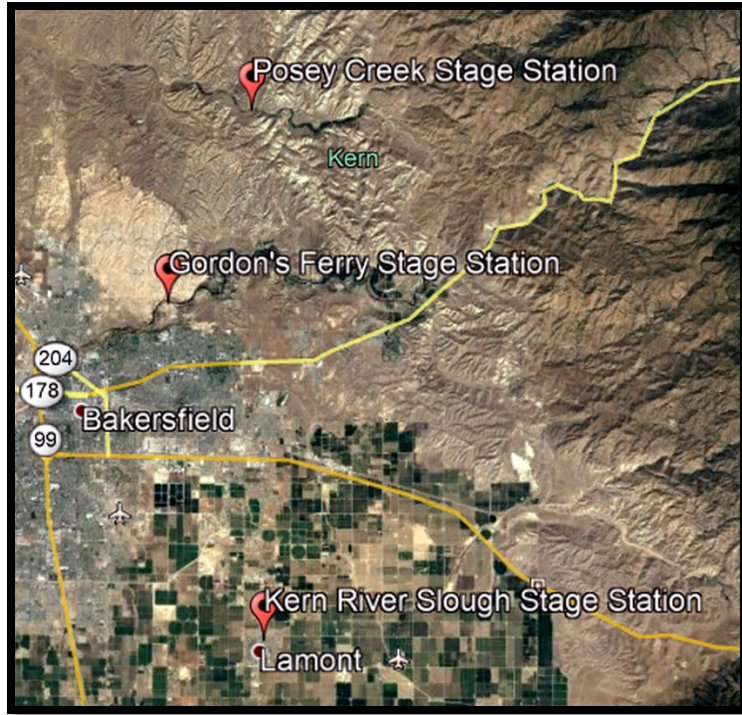

Figure 4.

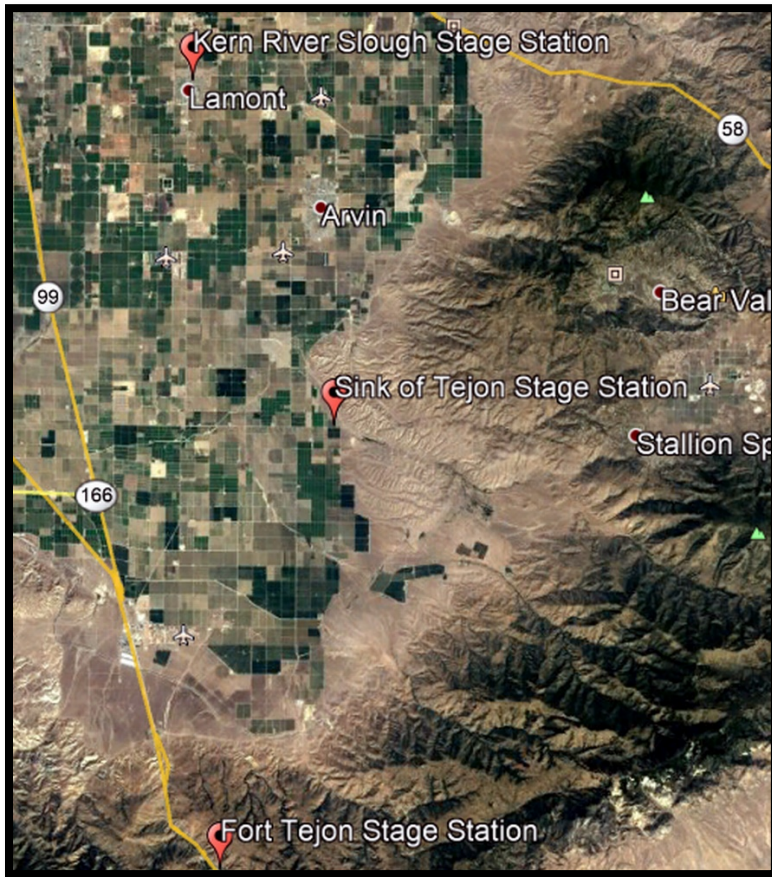

Figure 5.

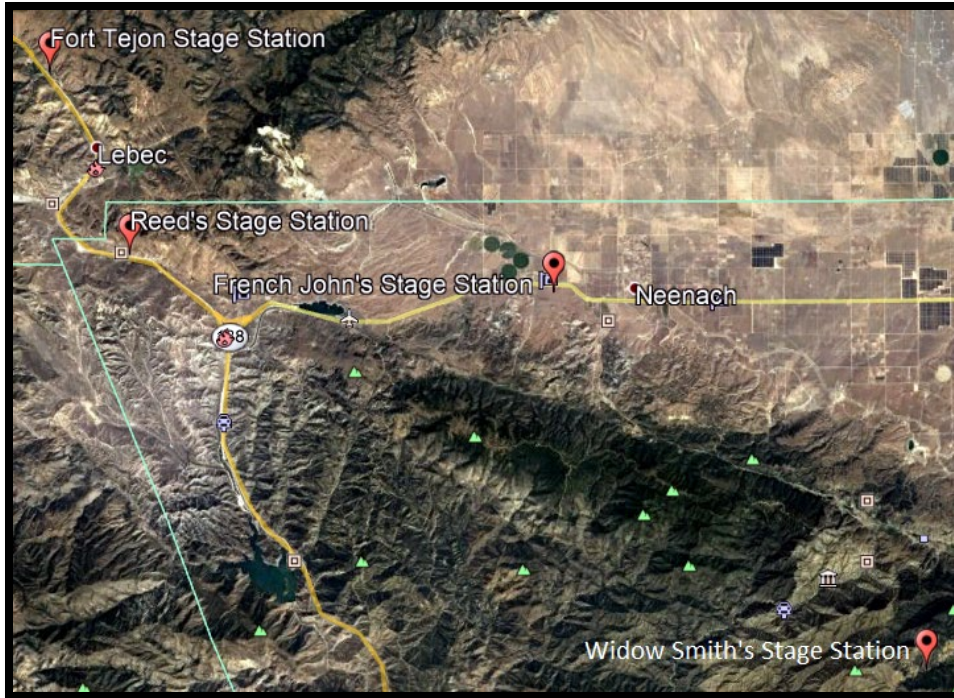

Figure 6.

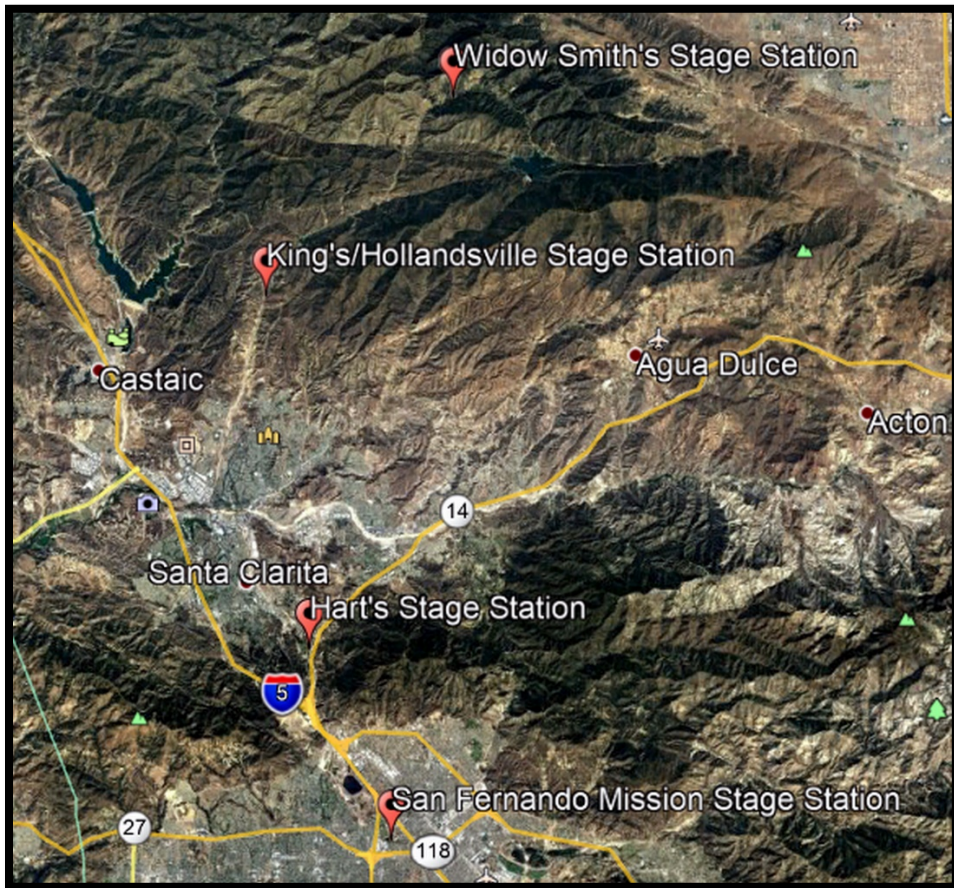

Figure 7.

San Fernando Mission Stage Station

GPS: 34.2730, -118.4615 (Approximate)

The location for Butterfield's San Fernando Mission Stage Station is definitively identified on the 1860 government-surveyed plat and in a *Sacramento Daily Union* newspaper article.



Figure 8. Butterfield's San Fernando Mission Stage Station was located in the southwest corner of the main building containing the church, as identified in the following newspaper article. From: General Land Office, *Plat of 8 Tracts of Land at the Mission San Fernando finally confirmed to J.S. Alemany, Bishop.*

Surveyed under Instructions from the U.S. Surveyor General by
Henry Hancock, Dep. Sur., February 1860.

The *Sacramento Daily Union* of August 14, 1858, published a brief history of the San Fernando Mission, identifying the location of Butterfield's stage station. It gives a good description of the mission at the time of establishing the station:

“We mentioned, yesterday, that a Committee of the Stage Agricultural Fair have been in the southern counties to examine the branches of industry in that portion of the State, preparatory to a report on the subject for the coming fair at Marysville. They visited the ex-Mission of San Fernando, Los Angeles county, the residence of Don Andreas [Andres] Pico, a number of the last Legislature, and a writer in the *Southern Vineyard* accompanied them. From his notes of the trip we extract the following: San Fernando lies about northwest from Los Angeles, distant about twenty-one miles, on the road to Fort Tejon and the Tulare valley. The Mission of San Fernando was founded in 1794, by the Franciscan Friars. The church and principal buildings are constructed of adobe, with massive walls, and are in a much better state of preservation than any other of the old Mission establishments with which we are acquainted. Quite a number of detached buildings are in a dilapidated condition, owing, as we are informed, to the using of the roofs for fuel by Col. Fremont in 1847, while on his way from the north to join Commander Stockton at this place.

“San Fernando is situated on a plain, which to the view is surrounded by mountains, forming a grand natural amphitheater. The central part of this valley is sandy, and in the absence of water for irrigation is not fertile. The mountain range which lies on the north spreads out northerly to the Tulare valley, and forms the shore of the ocean to the San Bernardino mountains, while a spur which protrudes from the mass along the sea shore passes inland in an easterly direction, separating this valley from Los Angeles. On the east, projecting curves and hills, through which the Los Angeles river bends its way, confine the view. The valley is about twelve miles broad and twenty in length, from east to west.

“[...] Under the preserving efforts of Mr. Pico, who held this Mission under lease in 1848, the buildings and enclosures have been preserved. He made eight hundred gallons of sweet oil in one year, from the olives of his garden, within the past three or four years. The olives of San Bernardino are unequalled in California, except those of San Diego, and for richness of flavor and delicate fiber, and are superior to the far-famed Italian Olive. The main source of water from which fields and gardens of San Fernando derived their supply was an artificial reservoir near the source of a small stream in the mountains, at some distance from the Mission, which has been neglected or purposely damaged, by which the outer fields have been neglected for some years.

After visiting the vineyards, we returned to the **mansion, and were shown over the house and church. The latter is situated in the rear of the mansion**, and is in good state of preservation, and is kept in order. Religious service is celebrated here monthly, by the resident priest of San Gabriel. The ornaments and consecrated vessels of this church were a few years since, by a decision of the Courts, removed to Los Angeles. **At the southwestern extremity of the main building, an extensive suit[e] of rooms is being prepared for the Overland Mail Stage and Transportation Company...**”



Figure 9. The mission is located in the middle of the triangle formed by Interstate 5, Interstate 405, and the Simi Valley Freeway (California 118) at the North end of the San Fernando Valley, to the North of Los Angeles. The Butterfield stage station was reported to be in the same building as the church.

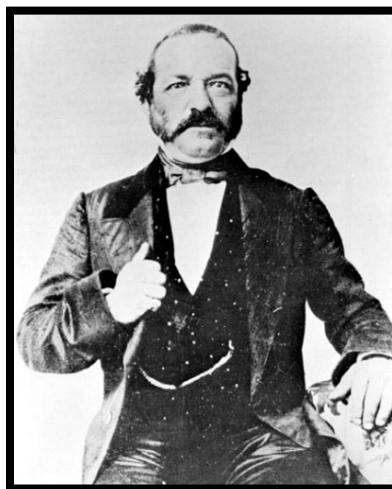

General Andres Pico

Figure 10. Owner of San Fernando Mission and Butterfield's Overland Mail Company station.
Courtesy: California State University, San Fernando Valley History Collection.

Hart's Stage Station

GPS: 34.3613, -118.5074 (Approximate)

I taped together the original 1870s General Land Office maps showing the surveyed route of the trail through the canyon. The scale is 1½" to the mile and is about 3' between Widow Smith's and Hart's. I have found that this method is quite accurate when cross-referenced to the distances given in primary sources.

In a study of Bailey's distances, I have found his are the most erroneous. Also, often the names he gives the stations are never mentioned again. He was very random in those observations. His initial report was not meant to be accurate both in distances and names but was merely a report to the Postmaster General to state whether the line would be successful. Indeed, in his report, he states on page 739: "This was compiled with great care, chiefly from data obtained on the road, and, *although it doubtless contains some errors, may be regarded as approximately correct.*"

Using the 1870s General Land Office maps, and measuring the surveyed trail, the total between Hart's and Widow Smith's is 22.8 miles. This is one time Bailey's estimates are close, as he gives King's as 10 miles from Widow Smith's and 12 miles from Hart's.

Josiah Hart was the reason, in September 1858, postal inspector Bailey named the station "Hart's." This was a large complex of buildings that served many purposes. According to the 1860 census, Thomas F. Williams was the station keeper there for the Overland Mail Company. Williams is listed as "Overseer O.M.," O.M. being Overland Mail.

Page No. 49

SCHEDULE 1.—Free Inhabitants in Sejón Township in the County of Los Angeles State of California enumerated by me, on the 24th day of July 1860. Simon Williamson Asst. Marshal.

Post Office Sticks of Sejón

493	Bernard Lockwood	48	m				800	NY
	Patrick Pomegran	24	m					"
494	Tho ^d Williams	29	m	Overseer O.M.			600	"
	unoccupied							
495	Josiah Hart	65	m	Farmer			150	Ken ^d
	Seas	22	m					Ark
	Martin	21	m					Texas
	Joseph	16	m					"
	Meredith	14	m					"
496	Aaron	28	m			1000	1500	Ark
	Catherine	20	f					Ms
	Caroline	1	f					Cal

Figure 11. The 1860 Federal Census listing Josiah Hart and Thomas E. Williams as the station keeper.

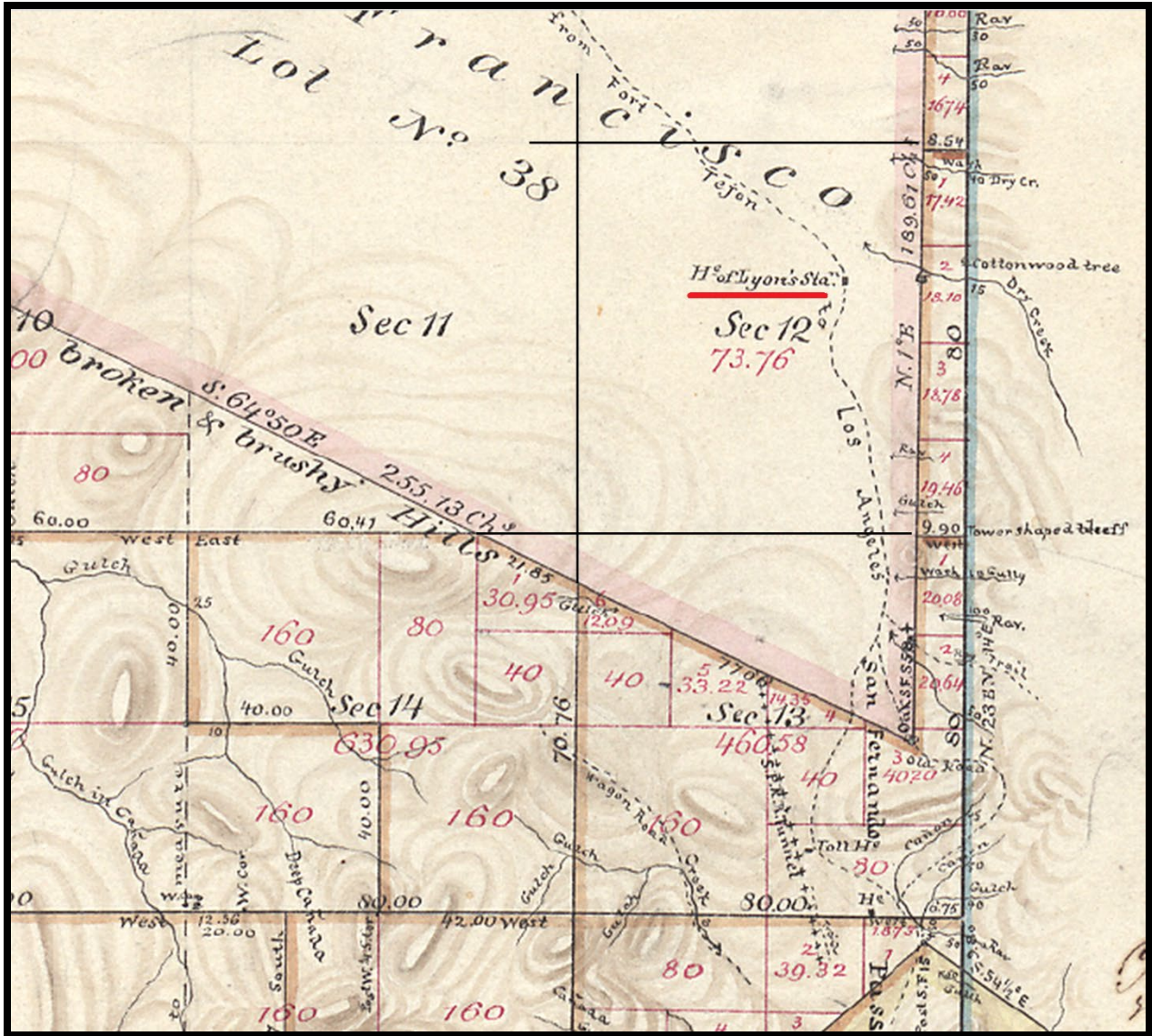

Figure 12. Hart's Stage Station is shown as Lyon's Station in Township 3N, Range 16W, Section 12, on this 1875 General Land Office map. At the bottom-right can be seen "San Fernando Pass."

Four months before Butterfield's Overland Mail Company started service, *Daily Alta California* correspondent William A. Wallace was on one of Phineas Banning's stage-coaches for a trip to Fort Tejon. In his report dated May 20, 1858, and published May 29, 1858, he wrote the following for Hart's stage station:

"I took a trip to the Tejon the other day, with Banning. We started at 4 A.M., and the fog enveloped us till we passed San Fernando. We lowered ourselves down the mountains, somewhat more carefully than Banning's usual custom. We took the horses out, and led them down; while the wheels of the carriage are locked, and Buchanan, and Mac and I, eased it down. Half a mile from the Pass, we came to old Hart's place. He came out with a

smile, and shook his white locks like a grizzly, as we unharnessed, preparatory to a hasty lunch. There was a large amount of stock in his corrals *en route* for the north — cows and calves mostly, and the finest to be found in this county; emigrants, also, and freight teams. In fact, there seemed to be a general gathering of moveable property, and, like ourselves, they were obliged to stop at old Hart's, because the next water is distant fifteen miles. The house scarcely deserves the name — it is only a stopping place. But one gets deceived if he expects to get any good drink here. The whiskey and brandy anywhere else would be warranted to kill at sight, and this was the only show we had for quenching thirst.”

A brief biography was given in the Memorial and Biographical History of the Counties of Fresno, Tulare, and Kern, California by Myron Angel, Chicago, Lewis Publishing Company, 1892:

“Josiah Hart was a hunter and trapper and followed the occupation for many years. He hunted buffalo and antelope in the Red River Valley as early as 1826, shipping his game down the Red River to market points. Lived in Texas until 1852 then came to Los Angeles County, leased a portion of the Azusa ranch and remained there until 1854 when he relocated to New Hall and stayed there till 1858, keeping a public ‘stopping place.’ In 1858 he became first settler of the Cummings valley, where he spent the rest of his life.”

By 1875, Hart's Stage Station was called Lyon's Stage Station. The *Los Angeles Herald* of March 28, 1875, gives a good description of the station in an article titled, “Up In The Mountains, Lyon's Station:”

“...The station proper is a well-constructed frame building about 30x60 feet in dimensions and answering at once the purposes of a store, Postoffice, telegraph office, depot and tavern, being, altogether, the head centre of the adjacent valley. Besides this there is a large stable, and, back towards the foot-hills on the West, a little cottage half hid by a heavy growth of mountain oak. This makes up the sum total of Lyon's Station.

Upon arrival we found our old friend Captain Kraszynski in charge, who was doing the honors of mine host in the absence of his brother, the proprietor of the establishment.”



Figure 13. The approximate site of Hart's Stage Station just west of Sierra Hwy and at the eastern edge of Eternal Valley Memorial Park in Newhall, California.

Hollandsville/King's Stage Station

GPS: 34.5234, -118.5318

It is 22.8 miles between Hart's and Widow Smith's using the 1870s General Land Office maps. Bailey's estimated distances were close, as he gives 22 miles. When Bailey's distances are plotted from Hart's and Widow Smith's, the location falls in Section 14 of Township 5N, Range 16W. In section 14 there is only one building shown, and that is of "C. Roggin."

Bailey's names for the stations were often only his observation and not heard of again. The popular name for this station during Butterfield's time was Hollandsville.

I have found no references for "King's" other than Bailey's, but I have found two newspaper articles, one from October 1860 and another from September 1860. Both call the station "Hollandsville."

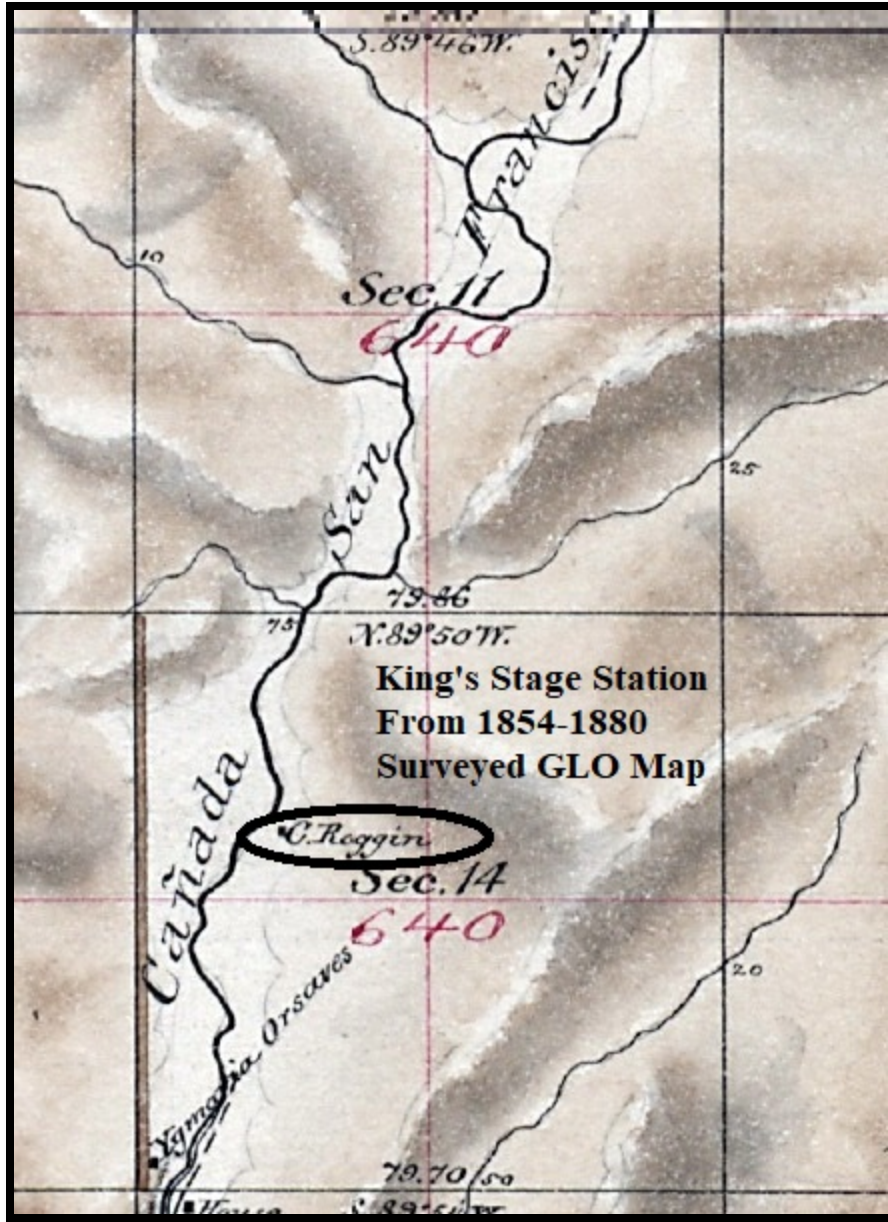

Figure 14. This General Land Office map for Township 5N, Range 16 W, has surveyed entries from 1854 to 1880. When distances are plotted from Hart's and Widow Smith's, they intersect in Section 14.



Figure 15. King's/Hollandsville Stage Station. The San Francisquito Canyon is very narrow, so that there would be very few wide-flat areas for a station. The location shown is based on the 1880 General Land Office map and the location shown as "C. Roggin."
The location is approximate.

The *Daily Alta California* of September 15, 1860, reported the murder of the station keeper:

"The driver of the stage which arrived from St. Louis this morning, reports the station keeper at Hollandsville Station, and a friend who was stopping with him, were both murdered on Wednesday morning by three Mexicans."

Widow Smith's Stage Station

GPS: 34.6145, -118.4275 (Within a stone's throw)

Although some secondary references have stated this Butterfield stage station was erected in 1859 by Aneas Gordon, Goddard Bailey identifies it in September 1858 as "Widow Smith's" in his government report to Post Master Aaron Brown. After Butterfield, the only primary source name for the station is "Delano's."

Using the 1877 surveyed General Land Office map, I superimposed it over a present-day topographical map to establish the location on the present-day map. I could then establish GPS coordinates by using Google Earth.

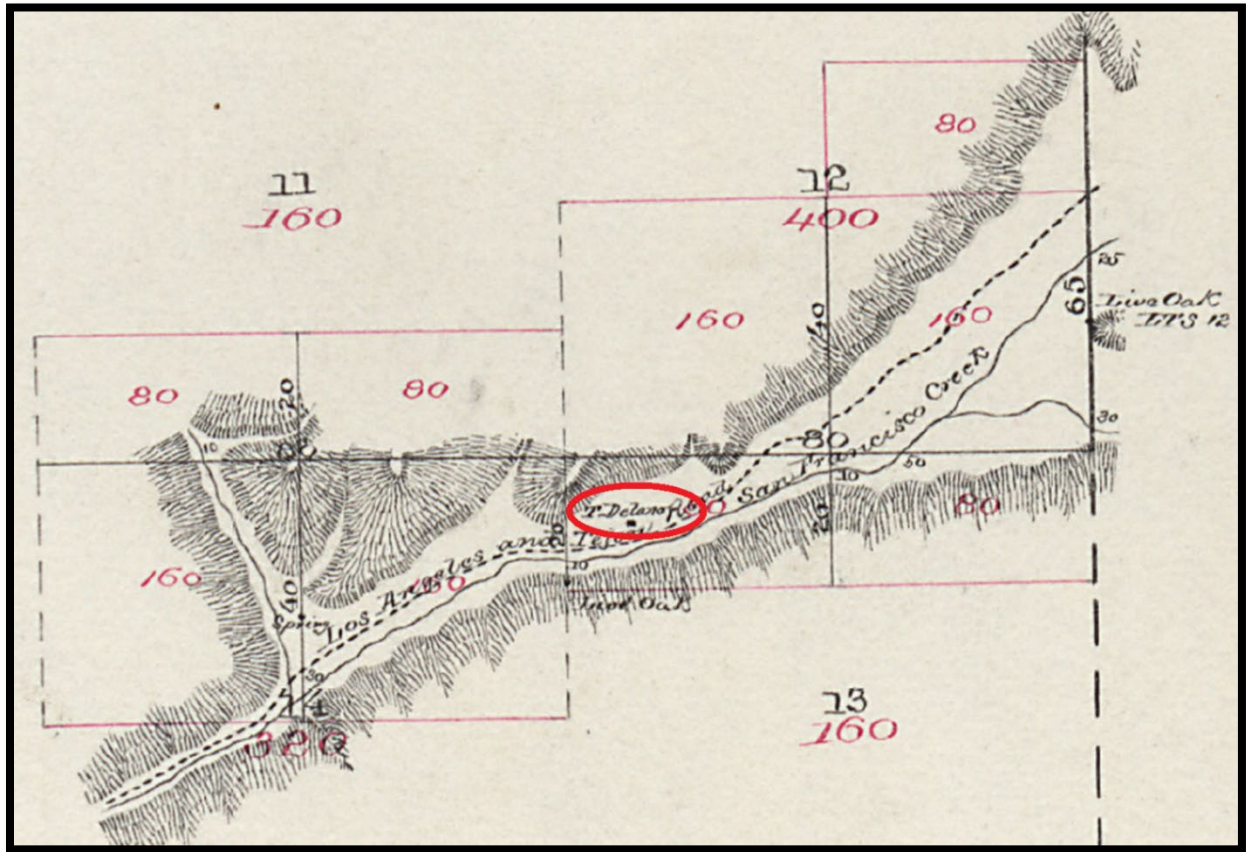

Figure 16. This General Land Office map Township 6N, Range 15W, Section 13, was surveyed 1877. It shows "T. Delano's," which was identified by Goddard Bailey as "Widow Smith's" in his 1858 government report to Postmaster General Aaron Brown.

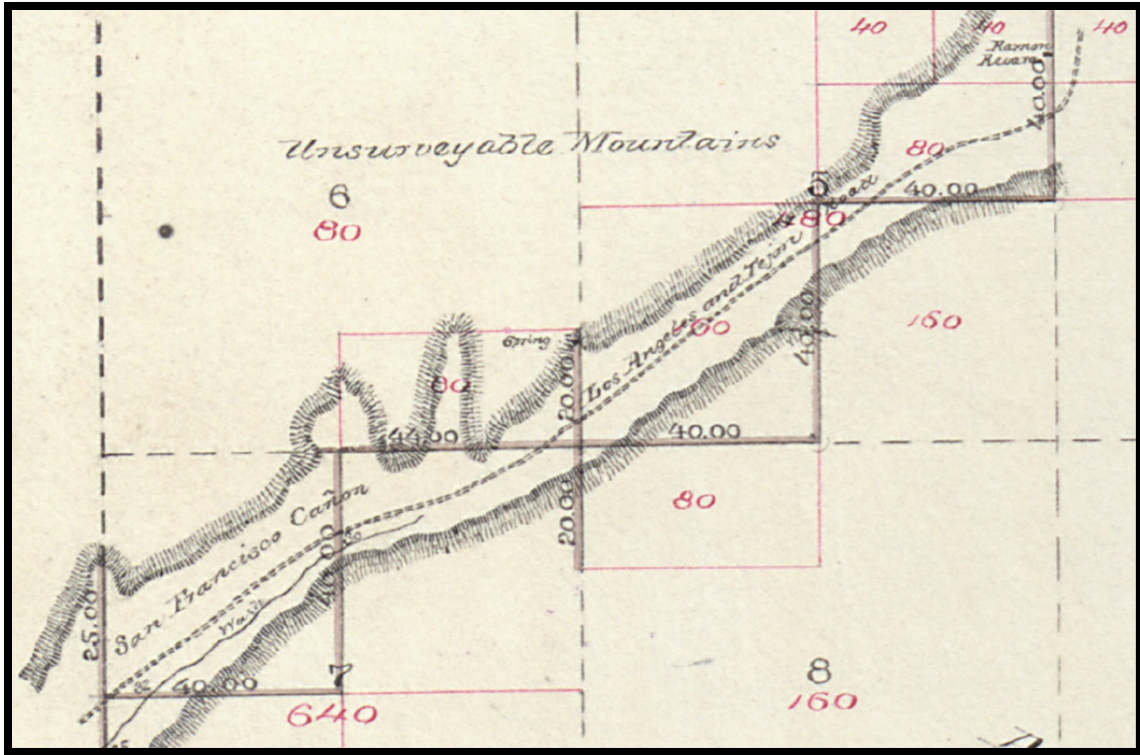

Figure 17. This is the trail going west from Widow Smith's.
 From: General Land Office map Township 6N, Range 14W, surveyed 1877.

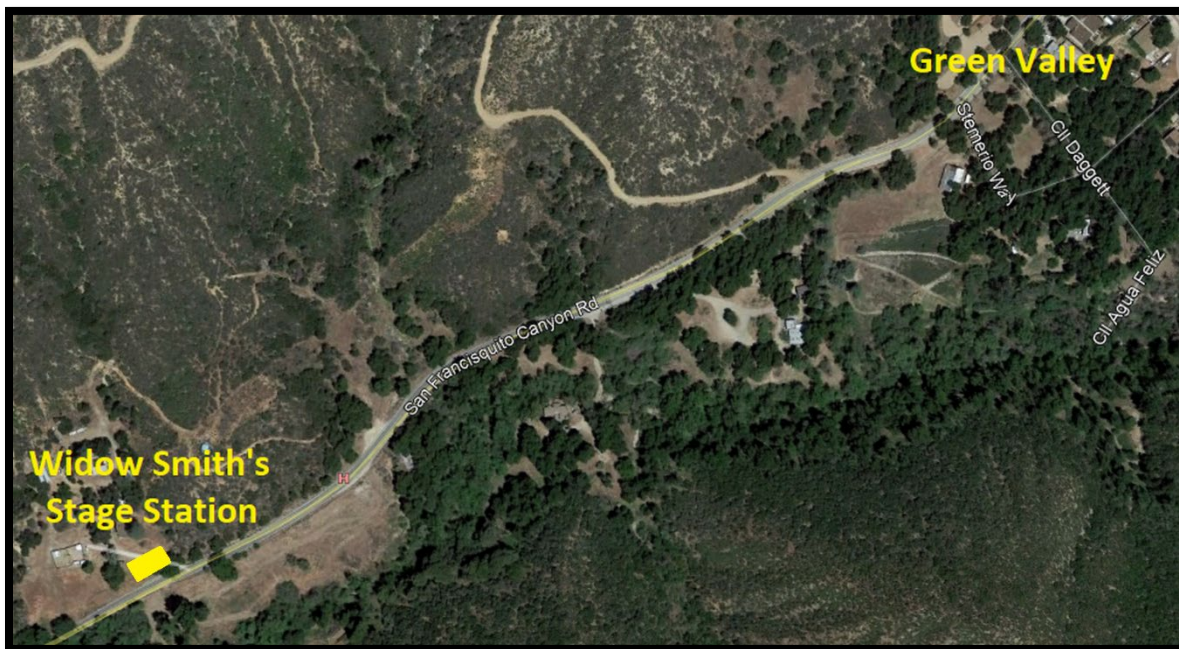

Figure 18. Widow Smith's Stage Station north of San Francisquito Canyon Road
 and about one-half mile southwest of the town of Green Valley.

French John's Stage Station
GPS: 34.7790, -118.6239 (within a stone's throw)

The station keeper was John Philburn, who was born in Ireland (listed on the 1860 census) – thus the earlier name of “Irish John’s” as noted in an article in the *Los Angeles Star* of June 26, 1858. The article was about Kenyon laying out the trail and selecting the station sites. Kenyon states, “from the Fort to French John’s, (late Irish John’s) 22 miles.” Kenyon measured the distances with a viameter (odometer).

Page No. 7
**SCHEDULE 1.—Free Inhabitants in San Angelo Township in the County of San Angelo State of California enumerated by me, on the 4th day of July, 1860. Silvan H. Lawrence Ass't Marshal
 Post Office San Angelo**

Dwelling-house in order of valuation	Families numbered in order of valuation	The name of every person whose usual place of abode on the first day of June, 1860, was in this family.	Description.			Profession, Occupation, or Trade of each person, male and female, over 15 years of age.	VALUE OF ESTATE OWNED.		Place of Birth, Naming the State, Territory, or Country.	Married within the year.	Attended School within the year.	Whether deaf and dumb, blind, insane, idiotic, pauper, or convict.	
			Age.	Sex.	White, Colored, or Indian.		Value of Real Estate.	Value of Personal Estate.					
1	2	3	4	5	6	7	8	9	10	11	12	13	14
65	64	John Philburn	33	m			1000	7000	Ireland				
		Mary	28	f									
		Henry	20	m					Trinity				
		Wm Porter	23	m		Labour			Ireland				
		Emilia Killa	2	m					Ireland				

Figure 19. The 1860 Census shows the name of “John Philburn” and has his place of birth as Ireland. The 1863 surveyed General Land Office map shows the location of “John Philburn’s House” which dovetails nicely with the “Irish John’s” in Kenyon’s report.

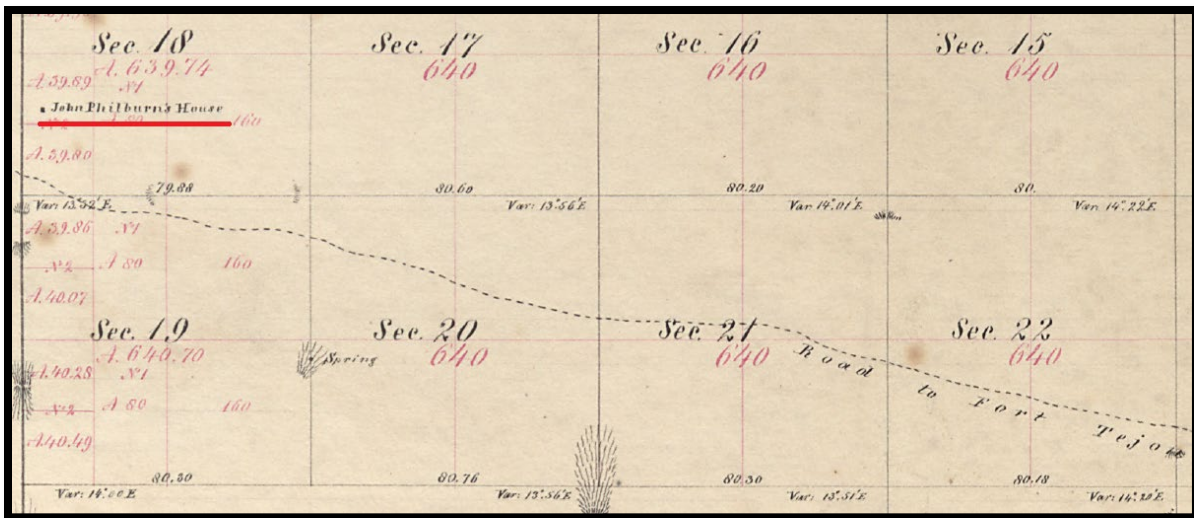

Figure 20. John Philburn’s (French John’s) House on General Land Office map in Township 8N, Range 16W, Section 18, surveyed 1855.



Figure 21. The location for French John's (John Philburn's) Butterfield Stage Station.

Reed's Stage Station

GPS: 34.7953, -118.8470 (within a stone's throw)

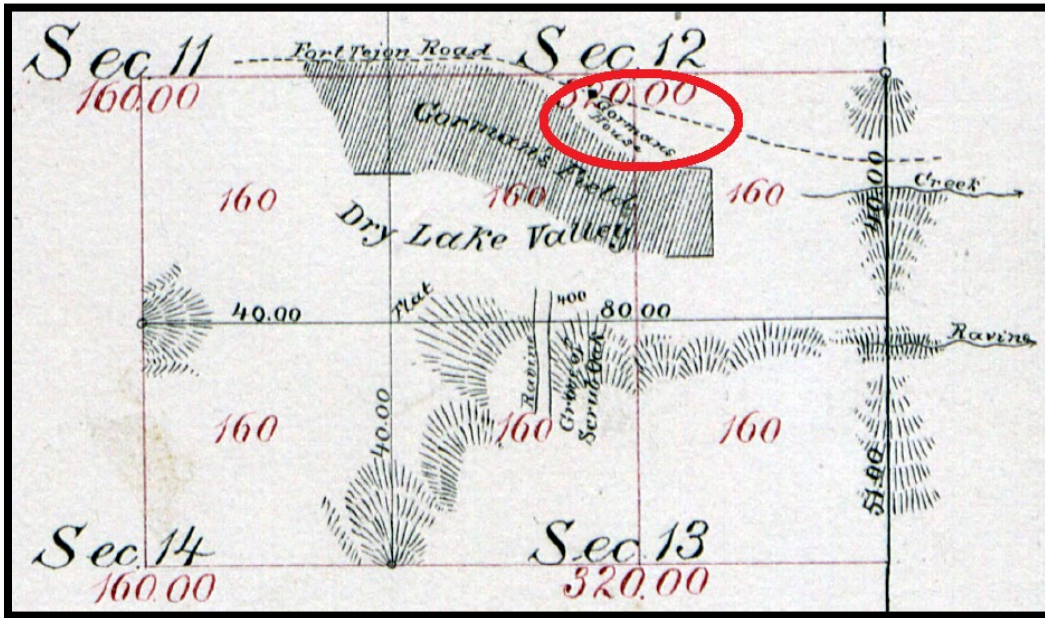

Figure 22. Butterfield's Reed's Stage Station location on General Land Office map of Township 8N, Range 19W, Section 12, surveyed in 1873. On the map it is "Gorman's House."

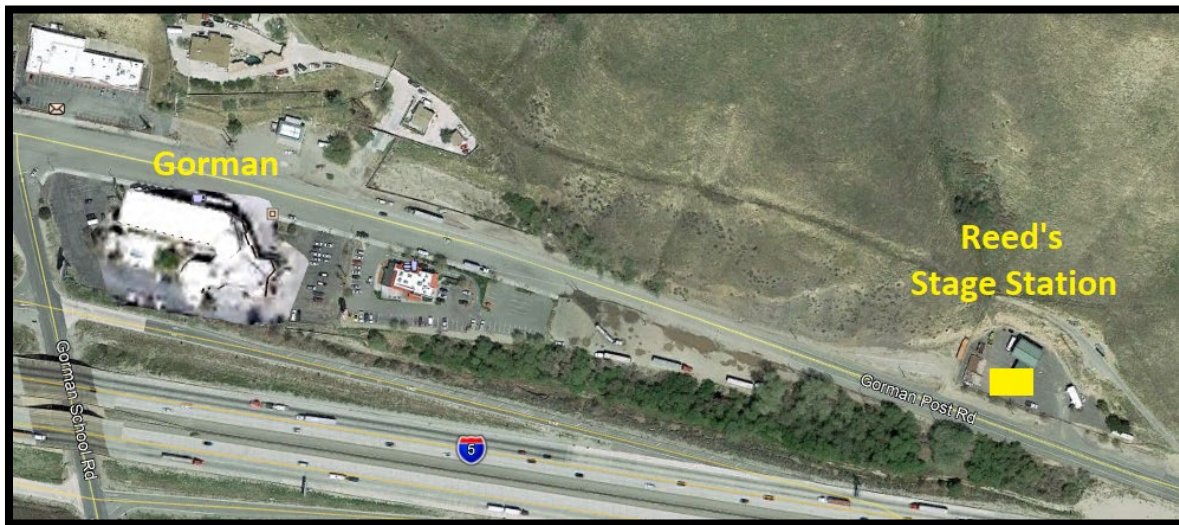

Figure 23. Butterfield's Reed's Stage Station. The present-day town of Gorman is 1/3 mile to the west.

The location is in the little notch in the hillside — a protected and logical place to build a station. This was done by superimposing the old General Land Office map over a present-day topographical map for the exact location.

Fort Tejon Stage Station

GPS: 34.8749, -118.8904 (within a stone's throw)

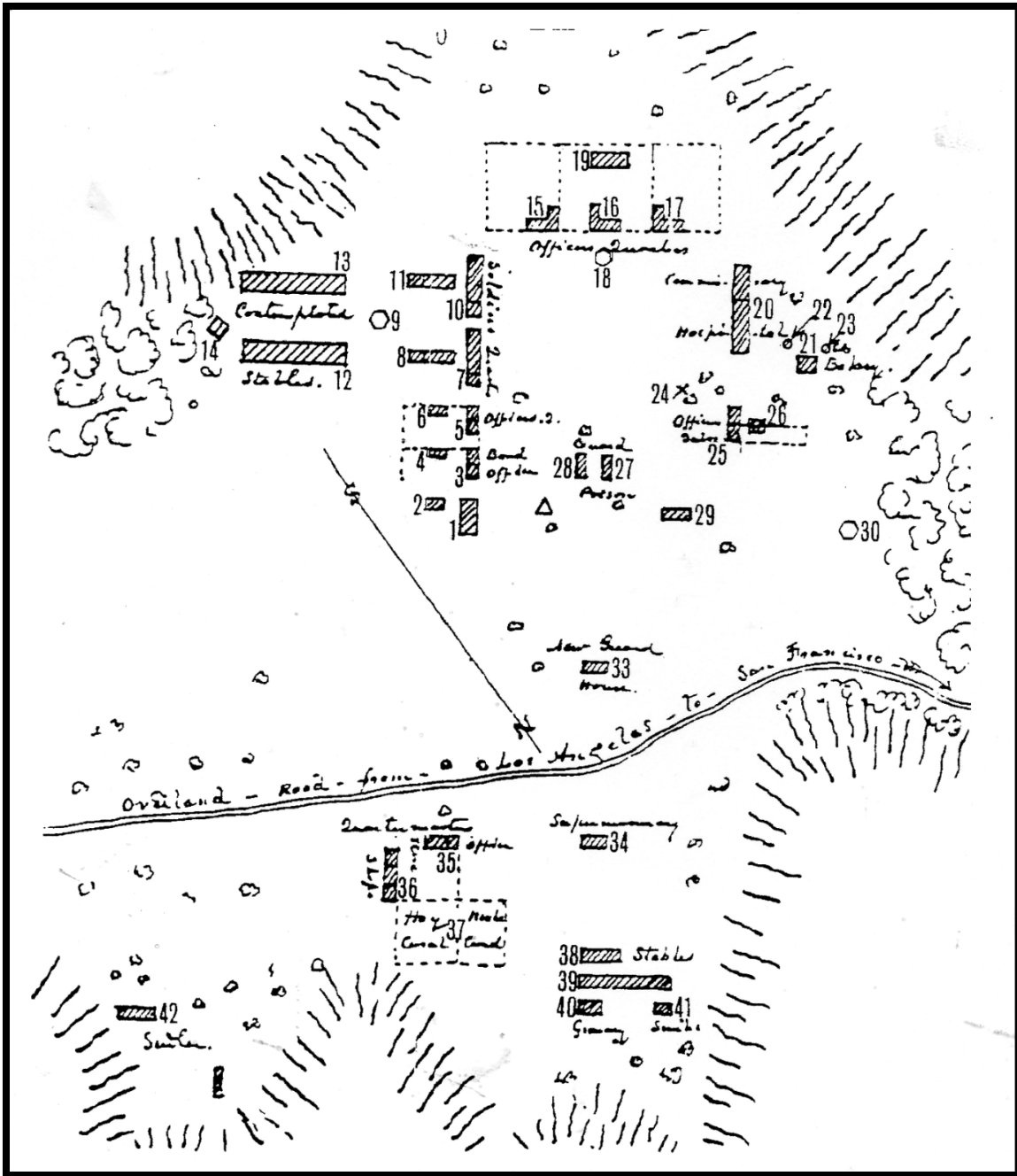

Figure 24. Map of Fort Tejon by Colonel Joseph K. F. Mansfield, 1859, Department of the Inspector General. Structure 42 is the Sutlery and Butterfield's Stage Station. From: California Military Department Historical Program, Joint Forces Headquarters, North Highlands, California.

The following is the history of the Butterfield Stage Station, structure 42, from the 1859 map drawn of Fort Tejon by Colonel Joseph K.F. Mansfield, Department of the Inspector General.

Fort Tejon State Park: An Interpretive History by George R. Stammerjohan

Extracted 16 March 2019 from *The Dogtown Territorial Quarterly*, Paradise, CA,
Nos. 31 (Fall 1997), 332 (Winter 1997) and 33 (Spring 1998)

42. Sutlery and Overland Mail. This is the approximate site of two or more structures. The two main buildings were adobe and are noted as the only hard-finished (plastered inside and outside) structures associated with the post. The Sutlery was started by Phineas T. Banning of San Pedro and operated by George C. Alexander who took over as the licensed sutler, or post trader, of Fort Tejon in 1856. This was also the Overland Mail Company station, post office, justice court and, after October 1860, the telegraph office.

The building closest to the Stockton-Los Angeles Road was the store and station of the mail company. It probably featured a billiard parlor and drinking room for officer use and also contained living quarters for Alexander and his several clerks. The telegraph office, managed by a fifteen-year-old boy (unidentified at present), was situated in the store. The store offered civilian goods at semi-regulated prices and luxury items at very inflated prices. Many eastern officers and their families found the prices unbelievably high. The sutler had a monopoly and charged usually five cents per man in the garrison as his fee to do business. On occasion, he served as substitute paymaster, a process which raised the ire of the Inspector General who visited the Department of the Pacific who believed the paymaster should visit the troops himself and in a timely fashion. Alexander himself had competition from the town of Fort Tejon located three-quarters of a mile south of the post.

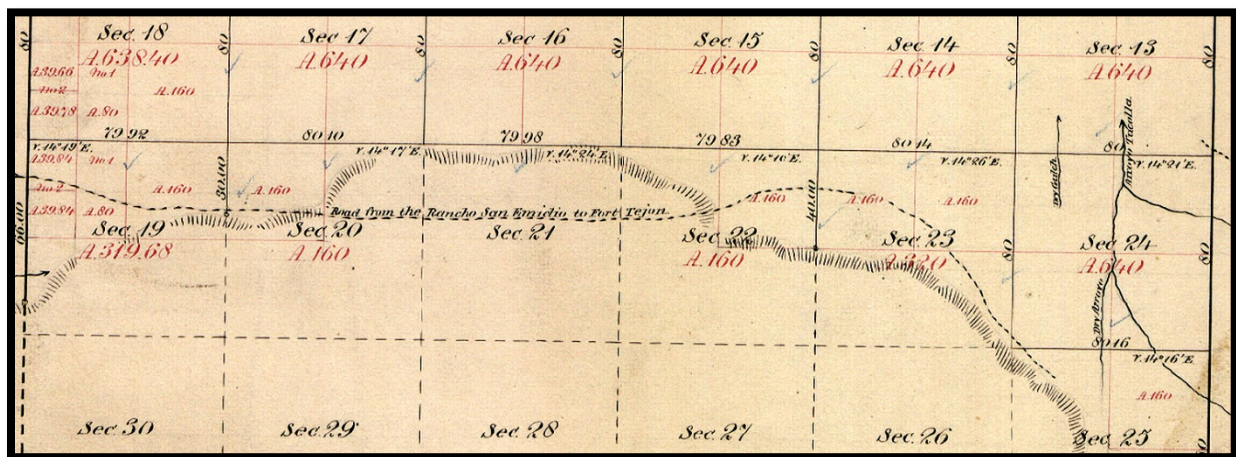

Figure 25. The trail west of Fort Tejon. From General Land Office map
Township 11N, Range 20W, surveyed 1862.



Figure 26. Approximate location for Butterfield's Fort Tejon Stage Station and trail. The location was determined from Colonel Joseph K.F. Mansfield's 1859 map of Fort Tejon.

Sinks of Tejon Stage Station
GPS: 35.0937, -118.8242 (ballpark)

The location for Sinks of Tejon Stage Station has been plotted to within a “ballpark.” I am giving this one a little more leeway because of the larger than normal distance that was used to plot the location.

A 1956 historical marker is located at the southwest corner of David and Wheeler Ridge roads, about 6 miles northeast of Mettler. It states the station is “Six miles east of this point.”

Gordon’s Stage Station location is known to be within about ± 0.1 mile. Bailey gives a distance from Gordon’s Ferry to Sinks of Tejon as 26 miles and states in his September 1858 report that this was only approximate. (Although the common name is “Sinks of Tejon,” Bailey identifies the location in his government report as “Sink” of Tejon.) Kenyon gave a report to the *Los Angeles Star*, June 26, 1858, in which he provided some of the distances measured with a viameter. He gives the distance from Gordon’s Ferry to Sinks of Tejon (misspelled as “Links of Tejon”) as 26½ miles.

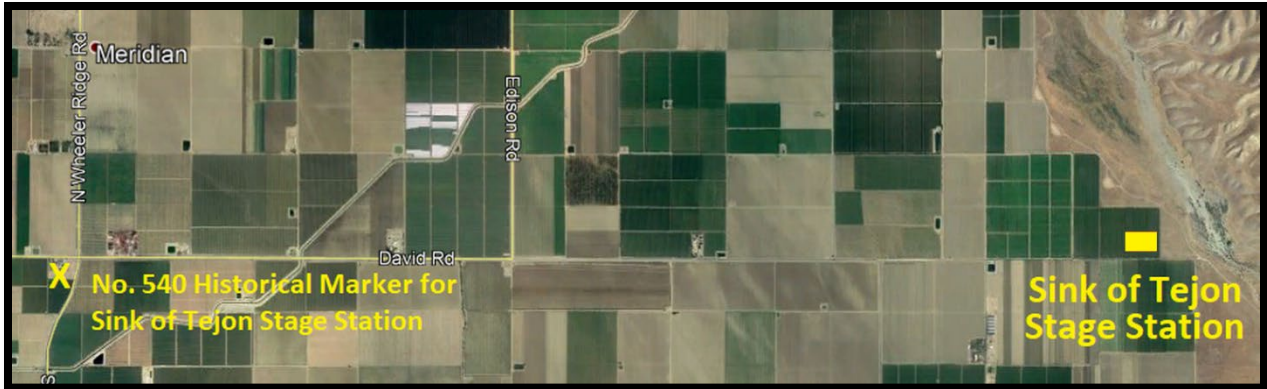

Figure 27. Butterfield's Sinks of Tejon Stage Station.



Figure 28. The 1956 historical marker located at the southwest corner of the junction with Wheeler Ridge Road and David Road, about 6 miles west of the location for Sinks of Tejon Stage Station.

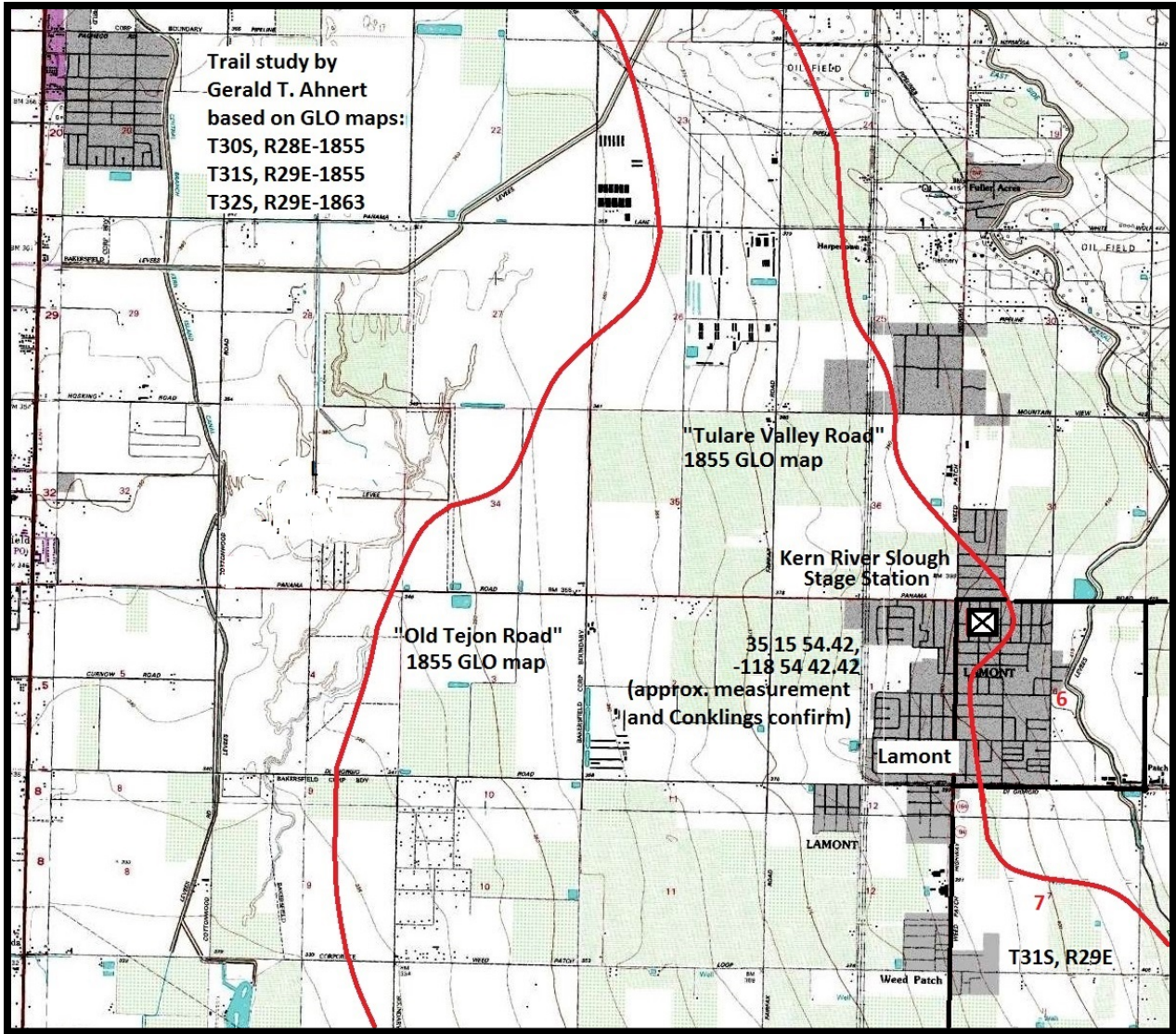

Figure 30. The location of Kern River Stage Station in the present-day town of Lamont.

Gordon's Ferry Stage Station
GPS: 35.4249, -118.9688 (within a stone's throw)

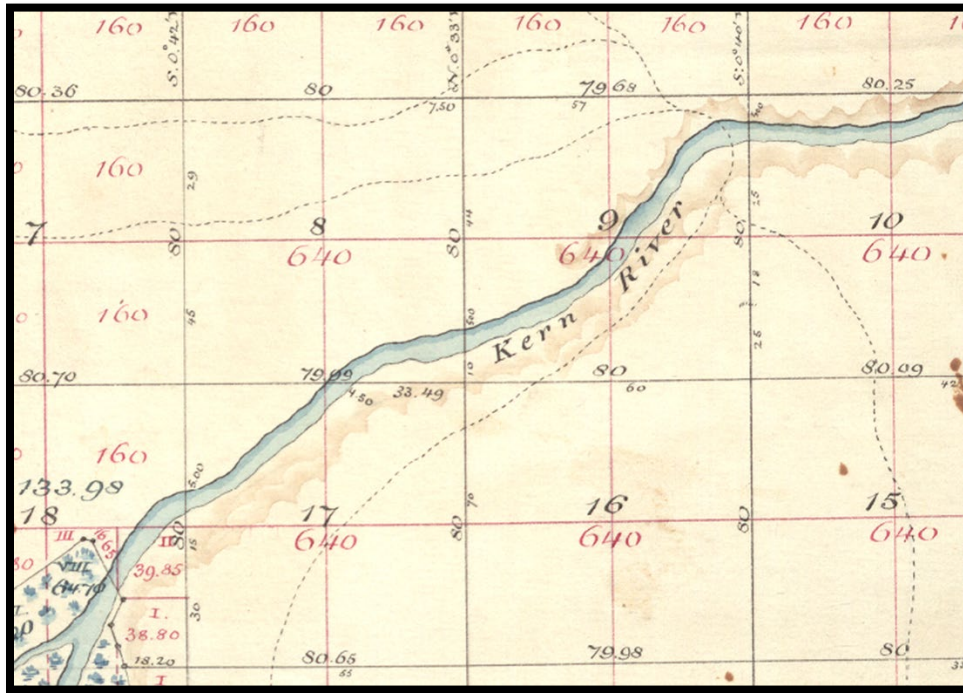

Figure 31. General Land Office map Township 29S, Range 28E surveyed in 1855. Gordon's Stage Station on the south bank of Kern River hadn't been established in 1855.

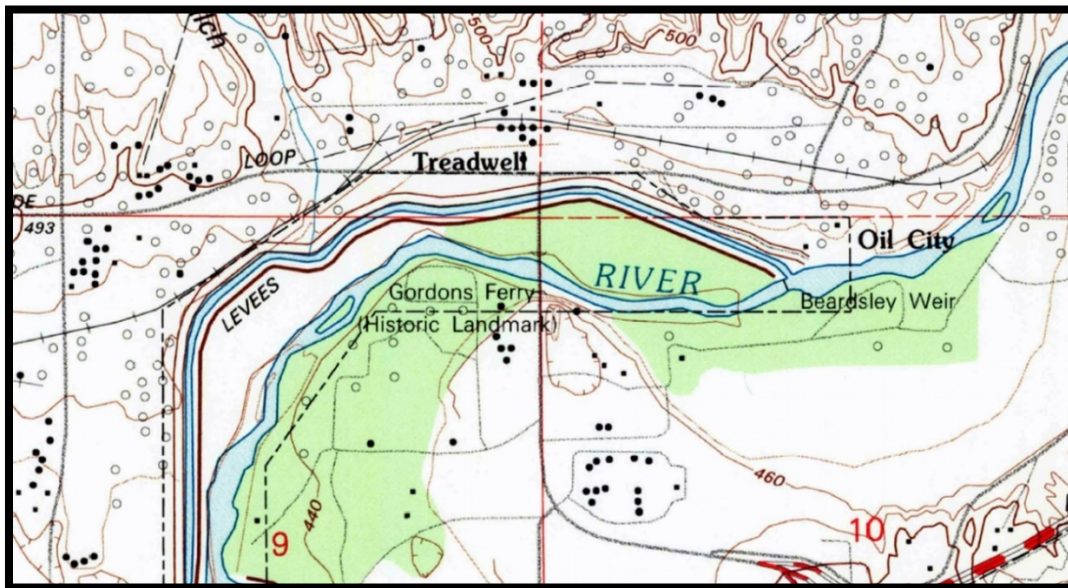

Figure 32. Gordon's Stage Station and Ferry. From: USGS Map 1992, Oil City, CA.



Figure 33. Historical marker for Gordon's Stage Station west of the crossing of Kern River.

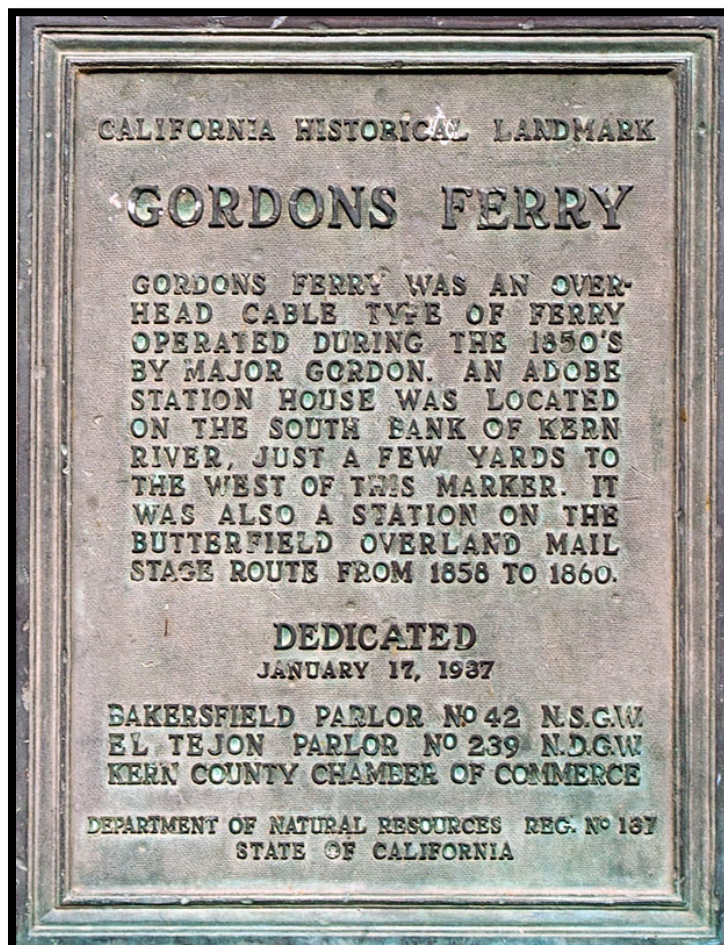

Figure 34. Historical marker No. 137 for Gordon's Stage Station and Ferry. The marker states that the station was a few yards to the west. Although the marker states it was a Butterfield Overland Mail Company station until 1860, in fact it remained in Butterfield's service until early 1861.

Although his first name was Anneas, he was commonly called Major Gordon.

Page No. 1

SCHEDULE 1.—Free Inhabitants in Township 28 S **in the County of** Palmer **State**
of California, **enumerated by me, on the** 5 **day of** June **1860.** William S. Painter **Ass't Marshal.**
Post Office Keeneyburg.

Dwelling-house, the order of valuation.	Families numbered in the order of valuation.	The name of every person whose usual place of abode on the first day of June, 1860, was in this family.	DESCRIPTION.			Profession, Occupation, or Trade of each person, male and female, over 15 years of age.	VALUE OF ESTATE OWNED.		Place of Birth, Naming the State, Territory, or Country.	Married within the year.	Attended School within the year.	Whether deaf and dumb, blind, insane, idiotic, pauper, or convict.	
			Age.	Sex.	Value, white, mulatto, or color.		Value of Real Estate.	Value of Personal Estate.					
1	2	3	4	5	6	7	8	9	10	11	12	13	14
8	8	Joseph Gale	51	M		Ferryman	300	1265	Washington D.C.				
		Reiza Gale	42	F	Ind.	Housekeeper			Walla Walla, O.R.				
		Margaret Gale	17	F	M	Seamstress			Oregon Territory				
		Mary Gale	15	F	M				Oregon Territory				
		Lucretia Gale	7	F	M				California				
		Clara Gale	5	F	M				California				
		John Hutchinson	52	M		Stage Driver		75	Virginia				
9	9	Francis Hostler	51	M		Hostler		50	Ireland				

Figure 35. The 1860 Federal Census lists Joseph Gale as “Ferryman.” He bought the ferry from Gordon sometime in 1859. Also listed is one of Butterfield’s stage drivers. It also shows there was another structure housing the “Hostler” (one who takes care of the livestock).

Posey Creek Stage Station

GPS: 35.5162, -118.9208 (where the trail crosses Poso Creek just south of Round Mountain Road)

The present name is “Poso” Creek, but during Butterfield’s time it was called “Posey” Creek. It has also been called “Posa” Creek.

When plotting the location, at 10 miles north of Gordon’s Ferry (location is known to within ±0.10 mile), the location falls in Township 28S, Range 28E, Section 1.



Figure 36. General Land Office map Township 28S, Range 28E, surveyed 1859.

This 1859 map made during the time of Butterfield’s service gives us much information. The trail is identified as “Overland Mail Stage Road from San Francisco to Memphis Tennessee [Tennessee] and St. Louis.” The mountain range at the bottom right is identified as “Summit of Divide between Kern River and Posey Creek.”

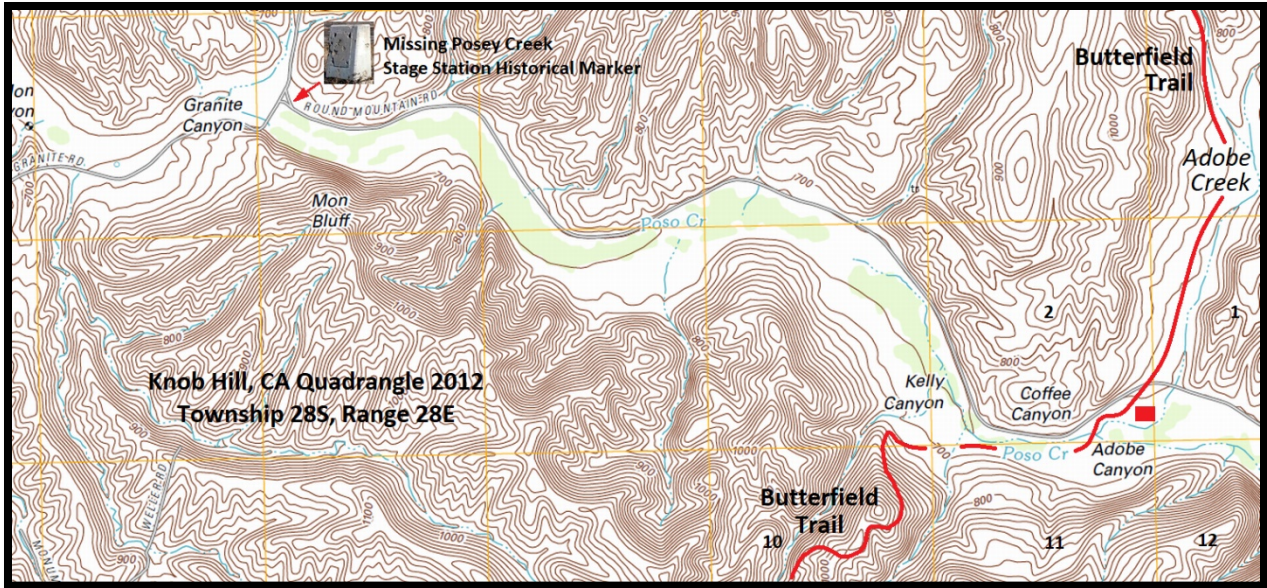

Figure 37. Posey Creek Stage Station at the junction of Poso Creek and Adobe Creek.

There is a monument 2½ miles west of the station site. The interpretive marker plaque is missing. It is at the intersection of Glenville-Bakersfield/Granite Road and Round Mountain Road. The inscription on the missing marker:

“Two and one-half miles east of this point stood the Posey Station on the Butterfield Overland Stage route that ran from St. Louis, Missouri through present-day Kern County to San Francisco during 1858-61, until the outbreak of the Civil War. (Marker Number 539).”

The red rectangle represents a probability for the station’s location based on geographic possibilities. Another possible location would be just south of Poso Creek in Section 11. Does the name “Adobe Canyon” indicate that there was once an adobe structure located in the canyon?



Figure 38: The monument shown on the map above. The interpretive marker is missing.

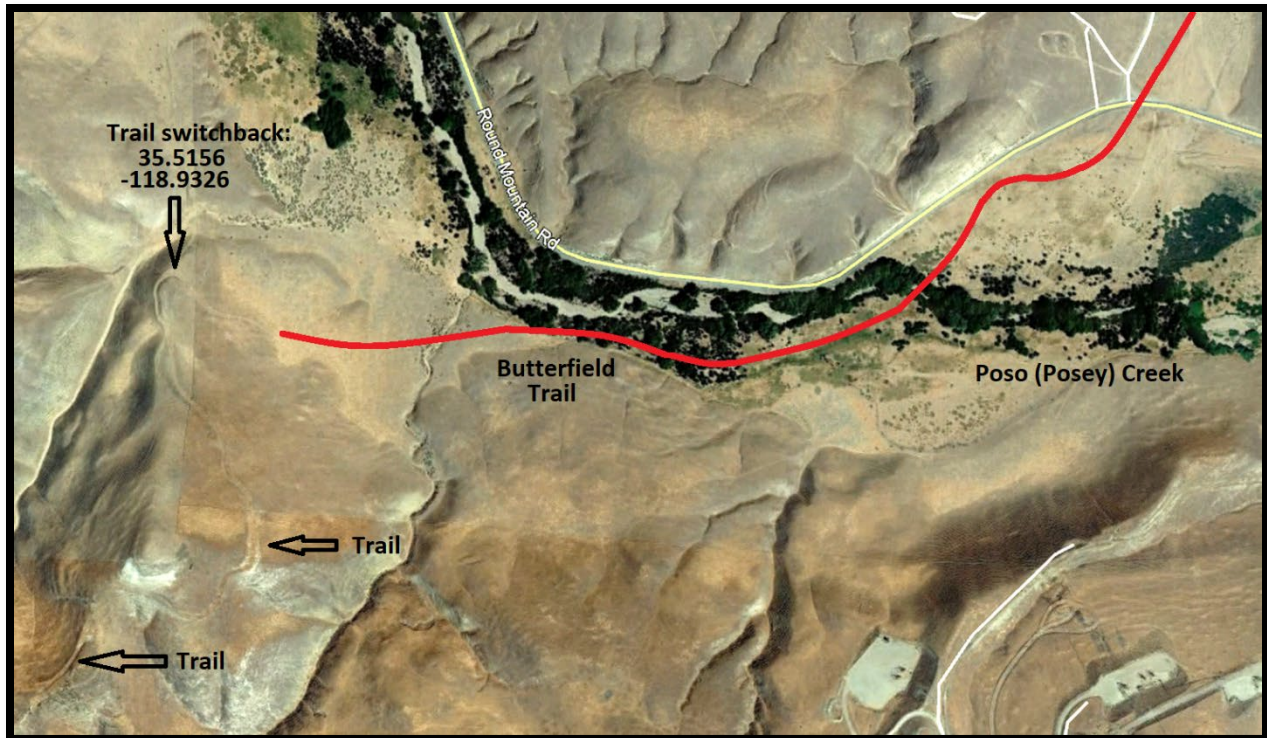

Figure 39. The trail can be clearly seen in the left on this satellite photo. The red line is based on the 1859 General Land Office map showing the trail. The 1859 map shows the general route of the trail on the side of the hill shown in this photo. Where the trail disappears as it descends from this hill into the creek basin, I have represented the approximate route of the trail as the red line.

Mysteries for Further Research

In the *Daily Alta California* of October 5, 1860, was an article from a correspondent who was on a Butterfield stage and reported “Mud Springs” between Widow Smith’s and French John’s. Goddard Bailey in his September 1858 report to Postmaster General Aaron Brown does not report this as a station in his itinerary. Nothing has yet been found to indicate this may have been a later Butterfield stage station. Further research may solve this mystery.

¹ Goddard Bailey, *Great Overland Mail*, Postmaster General, The Senate of the United States, Second Session, Thirty-Fifth Congress, 1858-59, Washington, 1858, pp. 742-743.

² Waddell F. Smith, *The Smoke Signal*: “The Pony Express - The Overland Mail,” Spring 1968, No. 17, published by The Corral of the Westerners, Tucson, Arizona.

³ *The Evening Star*, Washington D. C., April 29, 1858, “The California Overland Mail Company Contract.”

⁴ *The Evening Star*, Washington City, November 23, 1857.

⁵ *Ibid*, Bailey, p. 740.

⁶ *Los Angeles Star*, “The Overland Mail Company,” August 28, 1858.

⁷ Waterman L. Ormsby, New York Herald correspondent, *The Butterfield Overland Mail*, The Huntington Library, San Marino, California, p. 123.